

**iGERCN**

**CREDIT CARD**



About the technologies and problems of products,  
please login our company website or Send E-mail to us!



**iGERCN**<sup>®</sup>

**YUEQING IGER ELECTRIC CO.,LTD.**

Add: Room 303,building No.1,Unit 2,shanglaiqiao  
material decoration Area,liushi, Yueqing,Zhejiang,China 325604.

Factory: ShangmiAo,zndustrial zone,Yueqing  
Zhejiang,China 325604

Tel: +86-577-62731309

Fax: +86-577-27875953

MT/Wechat: 13968771068

E-mail:sales@igercn.com

www.igercn.com



# FLOOR SOCKET

**OEM/ODM/OBM**  
Product Selection Manual



**iGERCN**

# iGERCN

*Gold brick quality,  
professional service, choice iger!*



*Juanita*

86-577-62731309  
www.iger.cn.com

**FLOOR SOCKET**  
Product Selection Manual

## COMPANY PROFILE



YUEQING IGER ELECTRIC CO.,LTD is a professional manufacturer of intelligent socket And floor socket, intelligent timer and waterproof wall socket and switch in Zhejiang china more than 10years. Our products have been get the CE, ROHS, EESS, SAA, IK08, GCC, Qmark, EAC And 80% products have been exported to USA and European and Australia and South Asia Markets since 2010..

For many years our company have been improvement and innovation continuously on production manage system and quality control , and there Are more than 20 patent of invention and china exclusive patent for floor socket and intelligent socket was get.

The quality is our culture, with us your business is safe and successful. And OEM and ODM And OBM is supply for famous and strong company from the worldwide. You are welcome to Cooperate with us.



## WORKSHOP



## EXHIBITION



Guangzhou Electrical Building Technology  
And The Hannover Messer Exhibition And  
USA Smart Home Exhibition

# CONTENTS

YUEQING IGER  
ELECTRIC CO.,LTD

iGERCN

## TEMPERED GLASS FLOOR SOCKET



02 IGD-2F/123

## HIDDEN FLOOR SOCKET



18 ITD-12

## IP44 POP UP FLOOR SOCKET



03 IGD-2F /CC12  
04 IGD-111C  
05 IGD-2F/CC11  
06 IGD-125A/125C

## OPENING AND CONCEALED FLOOR SOCKET

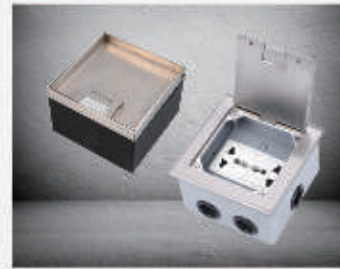

19 IGD-120K  
20 IGD-130KD  
21 IGD-180K / IGD-160KD  
22 IGD-250K,IGD-300K,  
IGD-2415KS  
23 IGD-2013KD  
24 IGD-XBK6/K8,K6/K8,  
K3520

## IP55 FLIDDING FLOOR SOCKET



07 HGD-2FD377  
08 IGD-2F/CC13

## PLASTIC TYPE FLOOR SOCKET CONCEPT TOWER SOCKET



26 ITD-622AS,624AS  
27 ITD-626AS,ITD-628AS  
28 IGZ531,IGZ532

## FAST AND SOFT POP UP FLOOR SOCKET



09 ITD-16/26  
10 IGD-2F  
11 IGD-2F/AC9  
12 IGD-2YSC1,IGD-2Y/BR,  
IGD-2F/SC6  
13 ITD-4DP-F,ITD-4DP-S  
14 IGD-270A  
15 ITD-1602  
16 IGD-3F

## MINI WARDROBE SOCKET UNIVERSAL SOCKET



29 HGZN-D06  
30 IG8668,IG8669

## NEW ARRIVAL

# IP44 TEMPERED GLASS SOCKET

Anti-collision, dusty-proof, anti-oxidation.  
Bearing weight: wheel pressure 200 kilogram.



**TEMPERED GLASS FLOOR SOCKET**

**IGD-2F/123 Floor Boxes Series (IP44)**



**Basic Parameter:**

Panel Dimension	120x120mm
Panel Material	Toughened Glass
Color	Black / Gray / White
Interface size	3 Modules
Bracket Material	Zinc Alloy & Alu Alloy
Basebox material	Steel+Zinc plated

◆ For special requirements & OEM/ODM service, please consult us.

**Product specifications:**

Part number	Panel material	Open style
IGD-2F/123	Tempered Glass	Fast Pop-up
IGD-2F/123S	Tempered Glass	Soft Pop-up

**Available sockets:**

**45 Type**

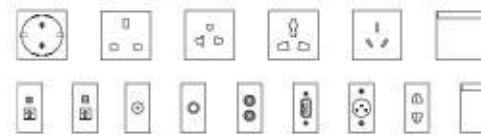

**118 Type**



**Outline Drawing:**

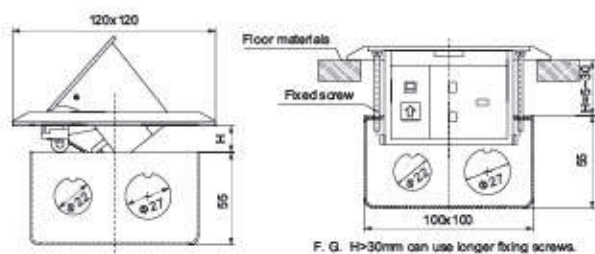

▲ Temporary lid Secure to box body during concrete pour to prevent ingress of slurry.

▲ Base box Ga-Steel box body: 100x100x55mm

**IP44 POP UP FLOOR SOCKET**

**IGD-2F/CC12 Floor Boxes Series (IP44)**



**Basic Parameter:**

Panel Dimension:	120x120mm
Panel Material:	Brass alloy & Alu alloy
Finishing:	Wire drawing/Polishing / Spray painting
Interface size:	3 Modules
Bracket Material:	Zinc Alloy & Alu Alloy
Basebox material:	Steel+Zinc plated

◆ For special requirements & OEM/ODM service, please consult us.

**Product specifications:**

Part Number	Panel Material	Open style
IGD-2F/CC12S	Brass Alloy(62%Cu)	Soft Pop-up
IGD-2F/AC12S	Alu- Alloy(85%Al)	Soft Pop-up

**Available sockets:**

**45 Type**

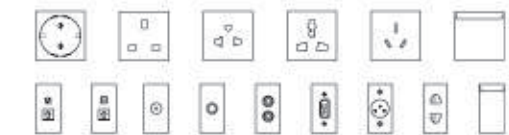

**118 Type**



**Outline Drawing:**

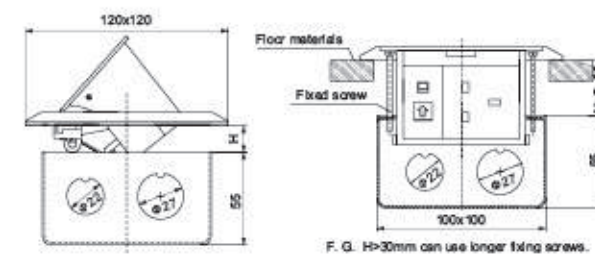

▲ Temporary lid Secure to box body during concrete pour to prevent ingress of slurry.

▲ Base box Ga-Steel box body: 100x100x55mm

**IP44 POP UP FLOOR SOCKET**

**IGD-111C Floor Boxes Series (IP44)**



**Basic Parameter:**

Panel Dimension:	120x120mm
Panel Material:	Brass alloy &Alu alloy
Finishing:	Wire drawing/Polishing / Spray painting
Interface size:	3 Modules
Bracket Material:	Zinc Alloy & Alu Alloy
Basebox material:	Steel+Zinc plated

◆ For special requirements & OEM/ODM service, please consult us.

**Product specifications:**

Part Number	Panel Material	Open style
IGD-111C	Brass Alloy(62%Cu)	Soft Pop-up

**Available sockets:**

**45 Type**

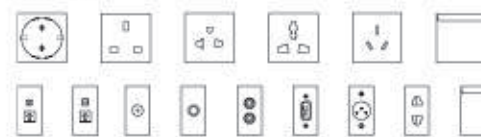

**118 Type**



**Outline Drawing:**

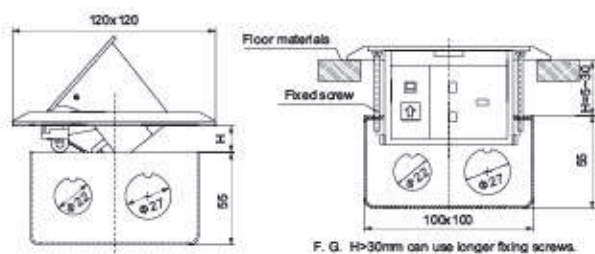

- ▲ Temporary lid Secure to box body during concrete pour to prevent ingress of slurry.
- ▲ Base box Ga-Steel box body: 100x100x55mm

**IP44 POP UP FLOOR SOCKET**

**IGD-2F/CC11 Floor Boxes Series (IP44)**



**Basic Parameter:**

Panel Dimension:	120x120mm
Panel Material:	Brass alloy &Alu alloy
Finishing:	Wire drawing/Polishing / Spray painting
Interface size:	3 Modules
Bracket Material:	Zinc Alloy & Alu Alloy
Basebox material:	Steel+Zinc plated

◆ For special requirements & OEM/ODM service, please consult us.

**Product specifications:**

Part Number	Panel Material	Open style
IGD-2F/CC11	Brass Alloy(62%Cu)	Soft Pop-up
IGD-2F/AC11	Alu- Alloy(85%Al)	Soft Pop-up

**Available sockets:**

**45 Type**

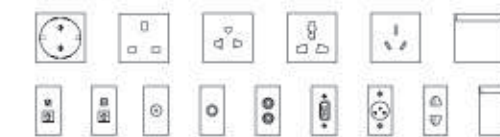

**118 Type**



**Outline Drawing:**

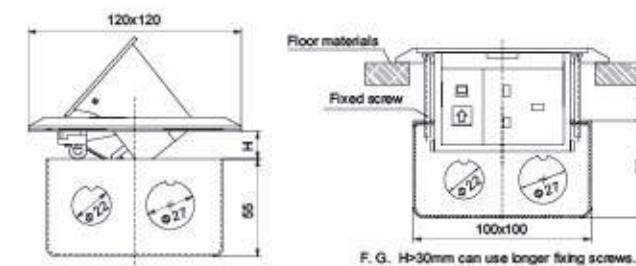

- ▲ Temporary lid Secure to box body during concrete pour to prevent ingress of slurry.
- ▲ Base box Ga-Steel box body: 100x100x55mm

**IP44 POP UP FLOOR SOCKET**

**IGD-125A/125C Floor Boxes**



**Basic Parameter:**

Panel Dimension	IGD-125A 145x125mm
Panel Material	Brass alloy & Alu-alloy
Finishing	Wire drawing/Polishing / Spray painting
Interface size	3 Modules
Bracket Material	Zinc Alloy & Alu Alloy
Basebox material	Steel+Zinc plated

◆ For special requirements & OEM/ODM service, please consult us.

**Product specifications:**

Part Number	Panel Material	Open style
IGD-125C	Brass Alloy(62%Cu)	Normal Pop-up
IGD-125A	Alu- Alloy (85%Al)	Normal Pop-up
IGD-125C/S	Brass Alloy(62%Cu)	Soft Pop-up
IGD-125A/S	Alu- Alloy (85%Al)	Soft Pop-up

**Available sockets:**

**45 Type**

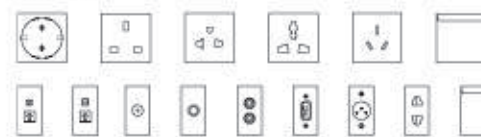

**118 Type**



**Outline Drawing:**

IGD-125A/IGD-125C

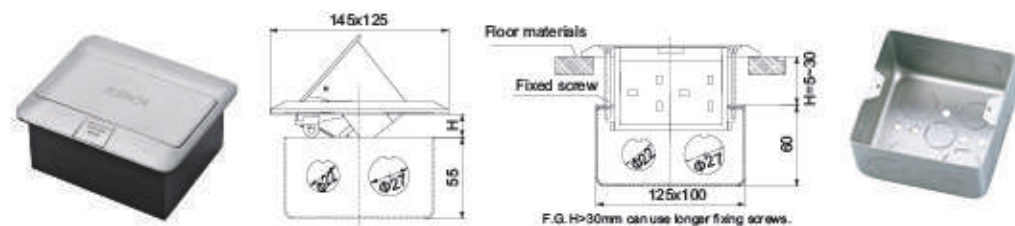

▲ Temporary lid Secure to box body during concrete pour to prevent ingress of slurry.

▲ Base box Ga-Steel box body: 125x100x60mm

**IP55 FLIDDING FLOOR SOCKET**

**HGD-2FD377 Flidding Floor Socket Series(IP55)**



**Basic Parameter:**

Panel dimensions	143x136mm
Panel Material	brass alloy&Aluminum alloy
Finishing	Wire drawing/Polishing / Spray painting
Interface size	Modules
Bracket Material	Zinc Alloy & Alu Alloy
Basebox material	Steel+Zinc plated

◆ For special requirements & OEM/ODM service, please consult us.

**Product specifications:**

Part Number	Panel Material	Open style
HGD-2FD377	Brass alloy(62%Cu)	slidding style
HGD-2FD377L	Aluminum alloy	slidding style

**Available sockets:**

**45 Type**

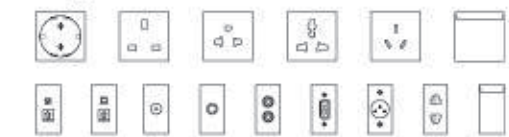

**118 Type**



**Outline Drawing:**

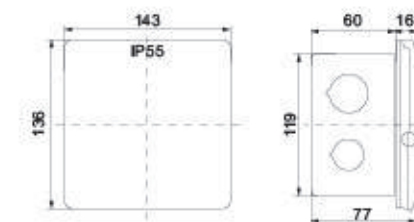

▲ Temporary lid Secure to box body during concrete pour to prevent ingress of slurry.

▲ Base box Ga-Steel box body: 119x119x60mm

**IP55 FLIDDING FLOOR SOCKET**

**IGD-2F/CC13 Flidding Floor Socket Series(IP55)**



**Basic Parameter:**

Panel dimensions	120x120mm
Panel Material	brass alloy&Aluminum alloy
Finishing	Wire drawing/Polishing / Spray painting
Interface size	3 Modules
Bracket Material	Zinc Alloy & Alu Alloy
Basebox material	Steel+Zinc plated

◆ For special requirements & OEM/ODM service, please consult us.

**Product specifications:**

Part Number	Panel Material
IGD-2F/CC13	Brass Alloy(62%Cu)
IGD-2F/CC13L	Aluminum Alloy

**Available sockets:**

45 Type

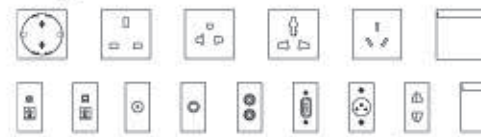

118 Type



**Outline Drawing:**

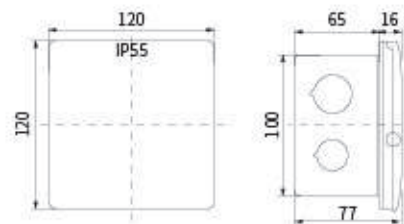

- ▲ Temporary lid Secure to box body during concrete pour to prevent ingress of slurry.
- ▲ Base box Ga-Steel box body: 100x100x65mm

**FAST AND SOFT POP UP FLOOR SOCKET**

**ITD-16/26 Floor Boxes Series**



IGD-2F/AC8



ITD-26



ITD-16



IGD-2F/AC8

**Basic Parameter:**

Panel Dimension:	(ITD-16)120x120mm (ITD-26)145x145mm (IGD-2F/AC8)145x145mm
Panel Material:	Brass alloy & Alu-alloy
Finishing:	Wire drawing/Polishing / Spray painting
Interface size:	(ITD-16),3 Modules (ITD-26),4 Modules (IGD-2F/AC8),3 Modules
Bracket Material:	Zinc Alloy & Alu Alloy
Basebox material:	Steel+Zinc plated

◆ For special requirements & OEM/ODM service, please consult us.

**Product specifications:**

Part Number	Panel Material	Open style
ITD-16/26	Brass Alloy(62%Cu)	Normal Pop-up
ITD-16L/26L	Alu- Alloy(85%Al)	Normal Pop-up
ITD-ZN-16/26	Brass Alloy(62%Cu)	Soft Pop-up
ITD-ZN-16L/26L	Alu- Alloy(85%Al)	Soft Pop-up

**Available sockets:**

45 Type



118 Type



**Outline Drawing:**

ITD-16

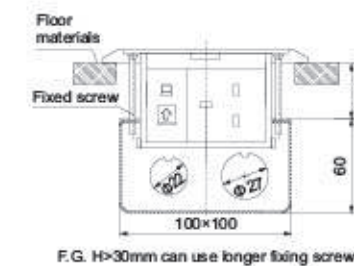
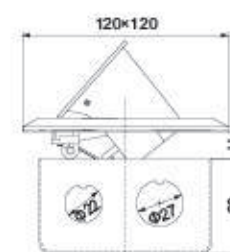

F.G. H>30mm can use longer fixing screws.

ITD-26,IGD-2F/AC8

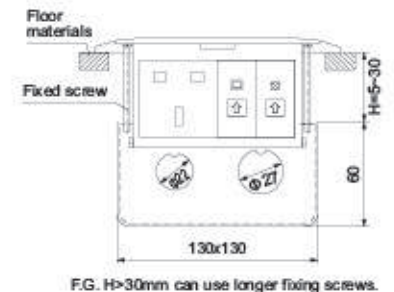
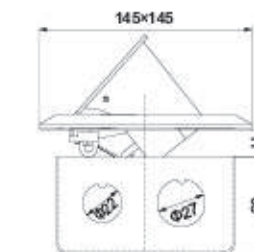

F.G. H>30mm can use longer fixing screws.



**FAST AND SOFT POP UP FLOOR SOCKET**

**IGD-2F Floor Boxes Series**



**Basic Parameter:**

Panel Dimension:	120x120mm
Panel Material:	Brass alloy &Alu alloy
Finishing:	Wire drawing/Polishing / Spray painting
Interface size:	3 Modules
Bracket Material:	Zinc Alloy & Alu Alloy
Basebox material:	Steel+Zinc plated

◆ For special requirements & OEM/ODM service, please consult us.

**Product specifications:**

Part Number	Panel Material	Open style
IGD-2F/CC1-F	Brass Alloy(62%Cu)	Fast Pop- up
IGD-2F/AC1-F	Alu- Alloy(85%Al)	Fast Pop- up
IGD-2F/CC1-S	Brass Alloy(62%Cu)	Soft Pop-up
IGD-2F/AC1-S	Alu- Alloy(85%Al)	Soft Pop-up

**Available sockets:**

**45 Type**

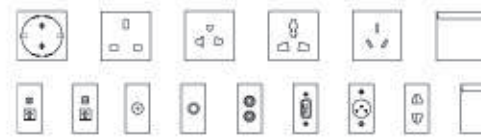

**118 Type**



**Outline Drawing:**

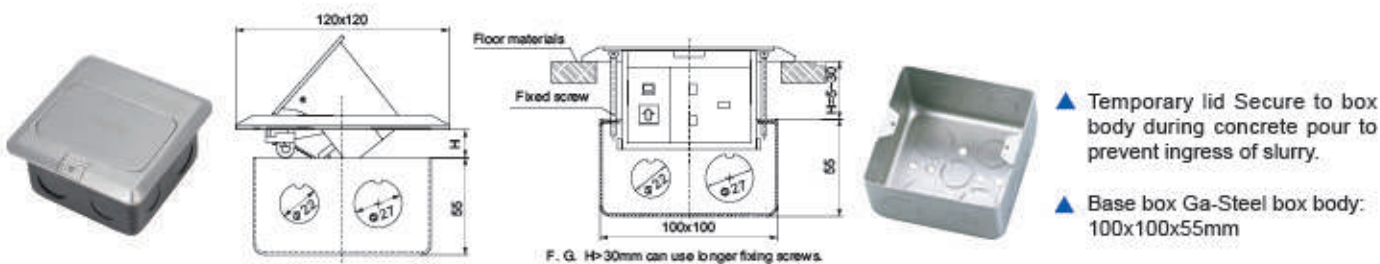

**FAST AND SOFT POP UP FLOOR SOCKET**

**IGD-2F/AC9 Floor Boxes Series**



**Basic Parameter:**

Panel Dimension:	120x120mm
Panel Material:	Brass alloy &Alu alloy
Finishing:	Wire drawing/Polishing / Spray painting
Interface size:	3 Modules
Bracket Material:	Zinc Alloy & Alu Alloy
Basebox material:	Steel+Zinc plated

◆ For special requirements & OEM/ODM service, please consult us.

**Product specifications:**

Part Number	Panel Material	Open style
IGD-2F/CC9-F	Brass Alloy(62%Cu)	Fast Pop- up
IGD-2F/AC9-F	Alu- Alloy(85%Al)	Fast Pop- up
IGD-2F/CC9-S	Brass Alloy(62%Cu)	Soft Pop-up
IGD-2F/AC9-S	Alu- Alloy(85%Al)	Soft Pop-up

**Available sockets:**

**45 Type**

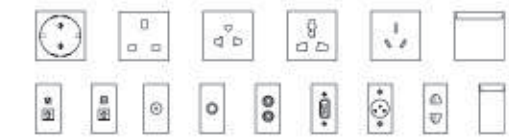

**118 Type**



**Outline Drawing:**

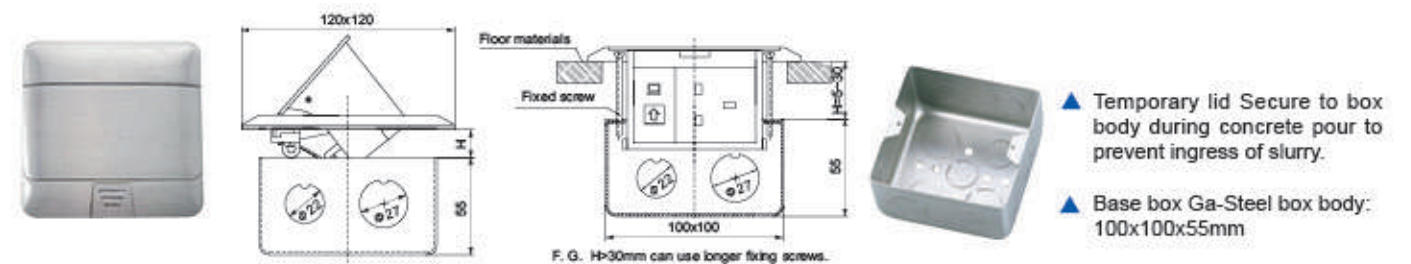

**FAST AND SOFT POP UP FLOOR SOCKET**

**IGD-2YSC1,IGD-2Y/BR,IGD-2F/SC6 Floor Boxes Series**



**Basic Parameter:**

Panel Dimension:	IGD-2YSC1 & IGD-2YBR: $\Phi$ 150mm IGD-2F/SC6: 120X120mm
Panel Material:	Brass alloy & Stainless-Steel
Finishing:	Wire drawing/Polishing / Spray painting
Interface size:	3 Modules
Bracket Material:	Zinc Alloy & Alu Alloy
Basebox material:	Steel+Zinc plated

◆ For special requirements & OEM/ODM service, please consult us.



**Product specifications:**

Part Number	Panel Material	Open style
IGD-2Y/SC1-F	Stainless- Steel	Fast Pop-up
IGD-2Y/BR-F	Brass Alloy(62%Cu)	Fast Pop-up
IGD-2F/SC6-F	Stainless- Steel	Fast Pop-up
IGD-2Y/SC1-S	Stainless- Steel	Soft Pop-up
IGD-2Y/BR-S	Brass Alloy(62%Cu)	Soft Pop-up
IGD-2F/SC6-S	Stainless- Steel	Soft Pop-up

**Available sockets:**

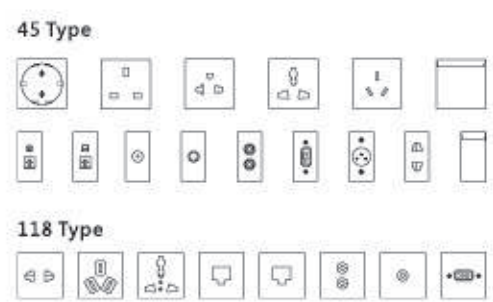

**Outline Drawing:**

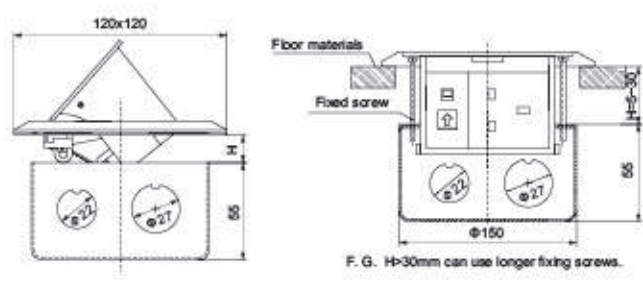

▲ Temporary lid Secure to box body during concrete pour to prevent ingress of slurry.

▲ Base box Ga-Steel box body: 100x100x55mm

**FAST AND SOFT POP UP FLOOR SOCKET**

**ITD-4DP-F,ITD-4DP-S Floor Boxes Series**



**Basic Parameter:**

Panel Dimension:	120x120mm
Panel Material:	Stainless-Steel
Finishing:	Wire drawing/Polishing / Spray painting
Interface size:	10 Modules
Bracket Material:	Zinc Alloy & Alu Alloy
Basebox material:	Steel+Zinc plated

◆ For special requirements & OEM/ODM service, please consult us.



**Product specifications:**

Part Number	Panel Material	Open style
ITD-4DP-F	Stainless-Steel	Fast Pop-up
ITD-4DP-S	Stainless-Steel	Soft Pop-up

**Available sockets:**

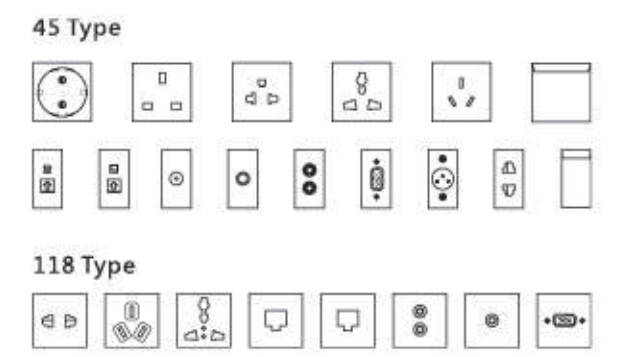

**Outline Drawing:**

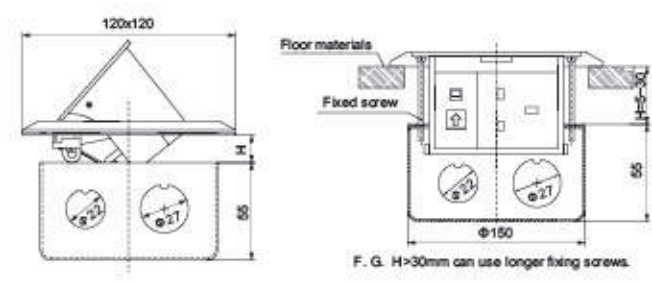

▲ Temporary lid Secure to box body during concrete pour to prevent ingress of slurry.

▲ Base box Ga-Steel box body: 100x100x55mm

**FAST AND SOFT POP UP FLOOR SOCKET**

**IGD-270A Floor Boxes Series**



**Basic Parameter:**

Panel Dimension:	270x120mm
Panel Material:	Brass alloy &Alu-alloy
Finishing:	Wire drawing/Polishing / Spray painting
Interface size:	8 Modules
Bracket Material:	Zinc Alloy &Alu Alloy
Basebox material:	Steel+Zinc plated

◆ For special requirements & OEM/ODM service, please consult us.

**Product specifications:**

Part Number	Panel Material	Open style
IGD-270C/F	Brass Alloy(62%Cu)	Fast Pop-up
IGD-270A/F	Alu- Alloy(85%Al)	Fast Pop-up
IGD-270C/S	Brass Alloy(62%Cu)	Soft Pop-up
IGD-270A/S	Alu- Alloy(85%Al)	Soft Pop-up

**Available sockets:**

**45 Type**



**118 Type**



**Outline Drawing:**

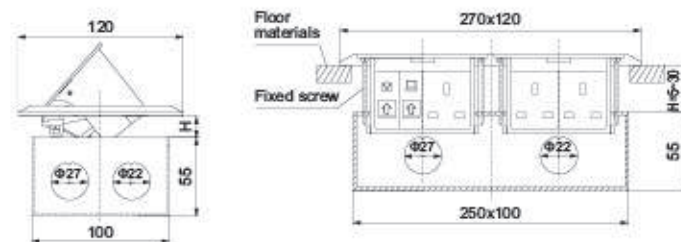

F.G. H>30mm can use longer fixing screws.



▲ Temporary lid Secure to box body during concrete pour to prevent ingress of slurry.

▲ Base box Ga-Steel box body: 200x100x55mm

**FAST AND SOFT POP UP FLOOR SOCKET**

**ITD-1602 Floor Boxes Series**



**Basic Parameter:**

Panel Dimension:	220x120mm
Panel Material:	Brass alloy &Alu-alloy
Finishing:	Wire drawing/Polishing / Spray painting
Interface size:	6 Modules
Bracket Material:	Zinc Alloy &Alu Alloy
Basebox material:	Steel+Zinc plated

◆ For special requirements & OEM/ODM service, please consult us.

**Product specifications:**

Part Number	Panel Material	Open style
ITD-1602	Brass Alloy(62%Cu)	Normal Pop-up
ITD-1602L	Alu- Alloy(85%Al)	Normal Pop-up
ITD-ZN-1602	Brass Alloy(62%Cu)	Soft Pop-up
ITD-ZN-1602L	Alu- Alloy(85%Al)	Soft Pop-up

**Available sockets:**

**45 Type**

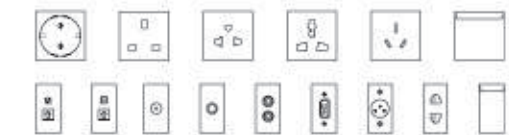

**118 Type**



**Outline Drawing:**

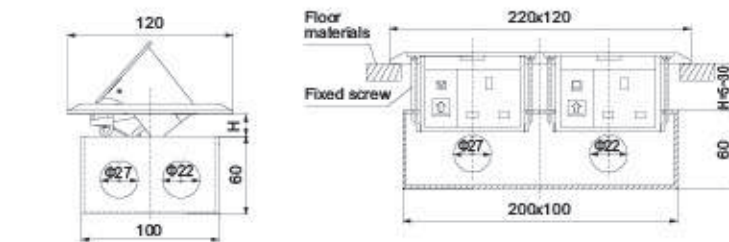

F.G. H>30mm can use longer fixing screws.



▲ Temporary lid Secure to box body during concrete pour to prevent ingress of slurry.

▲ Base box Ga-Steel box body: 200x100x60mm

**FAST AND SOFT POP UP FLOOR SOCKET**

**IGD-3F Floor Boxes Series**



**Basic Parameter:**

Panel Dimension:	220x120mm
Panel Material:	Brass alloy &Alu-alloy
Finishing:	Wire drawing/Polishing / Spray painting
Interface size:	6 Modules
Bracket Material:	Zinc Alloy &Alu Alloy
Basebox material:	Steel+Zinc plated

◆ For special requirements & OEM/ODM service, please consult us.

**Product specifications:**

Part Number	Panel Material	Open style
IGD-3F/CC2-F	Brass Alloy(62%Cu)	Fast Pop- up
IGD-3F/AC2-F	Alu- Alloy(85%Al)	Fast Pop- up
IGD-3F/CC2-S	Brass Alloy(62%Cu)	Soft Pop-up
IGD-3F/AC2-S	Alu- Alloy(85%Al)	Soft Pop-up

**Available sockets:**

**45 Type**

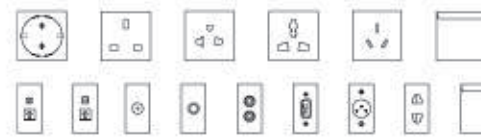

**118 Type**



**Outline Drawing:**

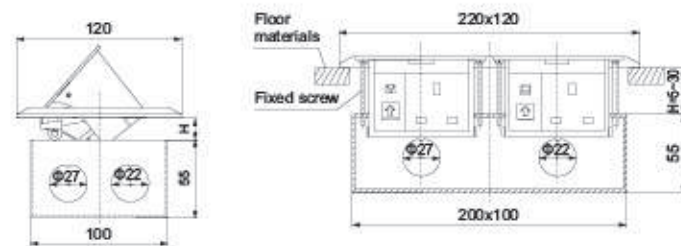

F.G. H>30mm can use longer fixing screws.



▲ Temporary lid Secure to box body during concrete pour to prevent ingress of slurry.

▲ Base box Ga-Steel box body: 200x100x55mm

**FAST AND SOFT POP UP FLOOR SOCKET**

**IGD-3F Black Floor Boxes Series**



**Basic Parameter:**

Panel Dimension:	220x120mm
Panel Material:	Brass alloy &Alu-alloy
Finishing:	Wire drawing/Polishing / Spray painting
Interface size:	6 Modules
Bracket Material:	Zinc Alloy &Alu Alloy
Basebox material:	Steel+Zinc plated

◆ For special requirements & OEM/ODM service, please consult us.

**Product specifications:**

Part Number	Panel Material	Open style
IGD-3F/AC2-F	Brass Alloy(62%Cu)	Fast Pop-up
IGD-3F/AC2-S	Alu- Alloy(85%Al)	Soft Pop-up

**Available sockets:**

**45 Type**

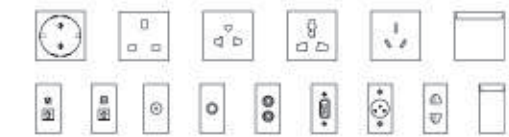

**118 Type**



**Outline Drawing:**

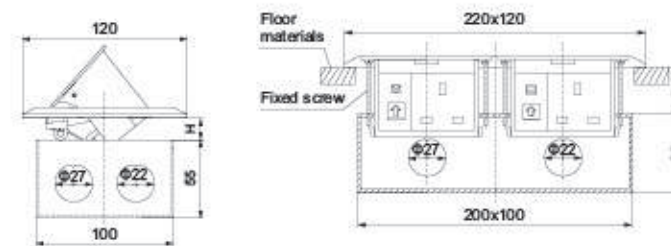

F.G. H>30mm can use longer fixing screws.



Temporary lid Secure to box body during concrete pour to prevent ingress of slurry.

Base box Ga-Steel box body: 200x100x55mm

**HIDDEN FLOOR SOCKET**

**ITD-12 Hidden Floor Socket**



ITD-12P



ITD-12

**Basic Parameter:**

Panel Dimension:	Φ135mm
Panel Material:	Brass alloy & Stainless-Steel
Finishing:	Wire drawing/Polishing / Spray painting
Interface size:	3 Modules
Bracket Material:	Zinc Alloy & Alu Alloy
Basebox material:	Steel+Zinc plated

◆ For special requirements & OEM/ODM service, please consult us.

**Product specifications:**

Part Number	Panel Material	Open style
ITD-12	Brass Alloy(62%Cu)	Open and hidden
ITD-12P	Stainless-Steel	Open and hidden

**Available sockets:**

45 Type

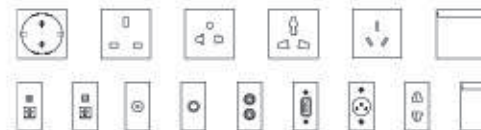

118 Type



**Outline Drawing:**

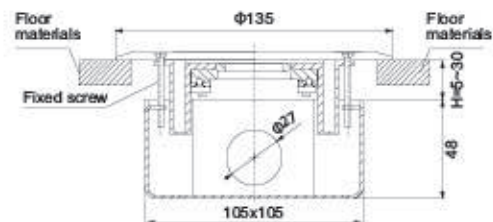

F.G. H>30mm can use longer fixing screws.



▲ Temporary lid Secure to box body during concrete pour to prevent ingress of slurry.

▲ Base box Ga-Steel box body: 105x105x48mm

**OPENING AND CONCEALED FLOOR SOCKET**

**IGD-120K Stainless Steel Floor Socket Box**



**Basic Parameter:**

Panel Dimension:	IGD-120K (120X120mm/4mm)
Panel Material:	Brass alloy & Stainless-Steel
Finishing:	Wire drawing/Polishing / Spray painting
Interface size:	2 Modules
Bracket Material:	Zinc Alloy & Alu Alloy
Basebox material:	Steel+Zinc plated

◆ For special requirements & OEM/ODM service, please consult us.

**Product specifications:**

Part Number	Panel Material	Open style
IGD-120K	Brass Alloy(62%Cu)	Open cover

**Available sockets:**

45 Type

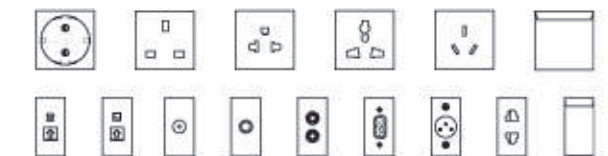

118 Type



**Outline Drawing:**

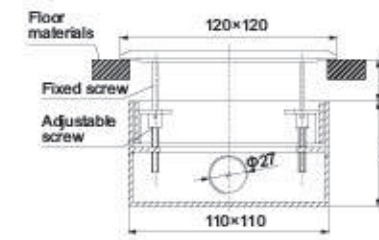

F.G. H>30mm can use longer fixing screws.



▲ Temporary lid Secure to box body during concrete pour to prevent ingress of slurry.

▲ Base box Ga-Steel box body: 110x110x65mm

**OPENING AND CONCEALED FLOOR SOCKET**

**IGD-130KD Floor Boxes Series**



**Basic Parameter:**

Panel Dimension:	130x130mm
Panel Material:	Stainless-Steel
Finishing:	Wire drawing/Polishing / Spray painting
Interface size:	4 Modules
Bracket Material:	Zinc Alloy &Alu Alloy
Basebox material:	Steel+Zinc plated

◆ For special requirements & OEM/ODM service, please consult us.



**Product specifications:**

Part Number	Panel Material	Open style
IGD-130KD	Stainless-Steel	Open cover

**Available sockets:**

**45 Type**

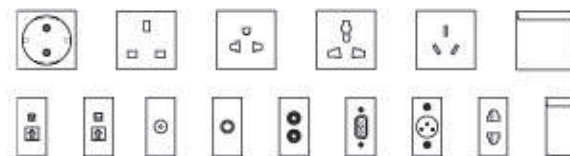

**118 Type**



**Outline Drawing:**

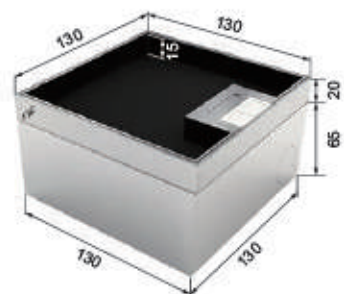

▲ Temporary lid Secure to box body during concrete pour to prevent ingress of slurry.

▲ Base box Ga-Steel box body: 130x130x65mm

**OPENING AND CONCEALED FLOOR SOCKET**

**IGD-180K / IGD-160KD Floor Socket Series**



IGD-180K

**Basic Parameter:**

Panel Dimension:	IGD-180K(180x180mm) IGD-160KD(160x160mm)
Panel Material:	Brass alloy & Stainless-Steel
Finishing:	Wire drawing/Polishing / Spray painting
Interface size:	10 Modules
Bracket Material:	Zinc Alloy &Alu Alloy
Basebox material:	Steel+Zinc plated

◆ For special requirements & OEM/ODM service, please consult us.



IGD-180K

**Product specifications:**

Part Number	Panel Material	Open style
IGD-180K	Brass Alloy(62%Cu)	Open cover
IGD-160KD	Stainless-Steel	Open cover

**Available sockets:**

**45 Type**

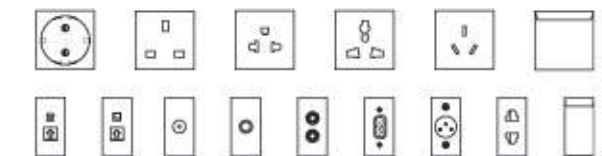

**118 Type**



**Outline Drawing:**

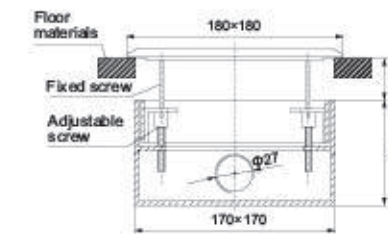

F.G. H>30mm can use longer fixing screws.

▲ Temporary lid Secure to box body during concrete pour to prevent ingress of slurry.

▲ Base box Ga-Steel box body: 170x170x80mm

**OPENING AND CONCEALED FLOOR SOCKET**

**IGD-250K,IGD-300K,IGD-2415KS Floor Boxes Series**



IGD-250K



IGD-300K



IGD-2415KS

**Basic Parameter:**

Panel Dimension:	IGD-250K(250 × 250mm) IGD-300K(300 × 120mm) IGD-2415K(240 × 155mm)
Panel Material:	Brass alloy & Stainless-Steel
Finishing:	Wire drawing/Polishing / Spray painting
Interface size:	8 Modules
Bracket Material:	Zinc Alloy &Alu Alloy
Basebox material:	Steel+Zinc plated

◆ For special requirements & OEM/ODM service,please consult us.

**Product specifications:**

Part Number	Panel Material	Open style
IGD-250K	Stainless steel(#304)	Open cover
IGD-300K	Stainless steel(#304)	Open cover
IGD-2415KS	Stainless steel(#304)	Open cover

**Available sockets:**

**45 Type**

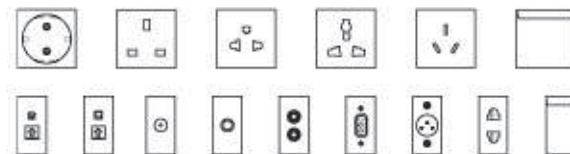

**118 Type**



**Outline Drawing:**

IGD-300K

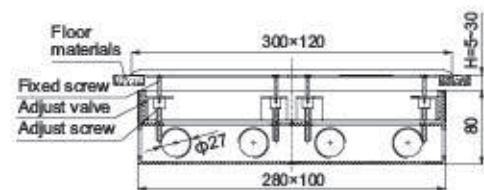

F. G. H>30mm can use longer fixing screws.

IGD-2415KS

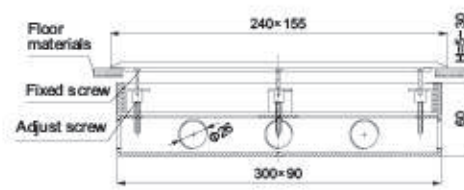

F.G. H>30mm can use longer fixing screws.

**OPENING AND CONCEALED FLOOR SOCKET**

**IGD-2013KD Floor Boxes Series**



**Basic Parameter:**

Panel Dimension:	IGD-2013KD (200 X 130mm/4mm)
Panel Material:	Brass alloy & Stainless-Steel
Finishing:	Wire drawing/Polishing / Spray painting
Interface size:	8 Modules
Bracket Material:	Zinc Alloy &Alu Alloy
Basebox material:	Steel+Zinc plated

◆ For special requirements & OEM/ODM service,please consult us.

**Product specifications:**

Part Number	Panel Material	Open style
IGD-2013KD	Stainless steel(#304)	Open cover

**Available sockets:**

**45 Type**

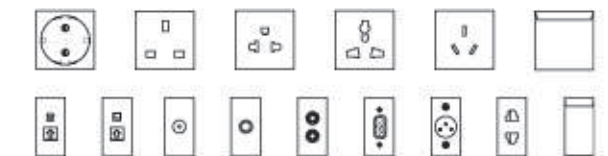

**118 Type**



**Outline Drawing:**

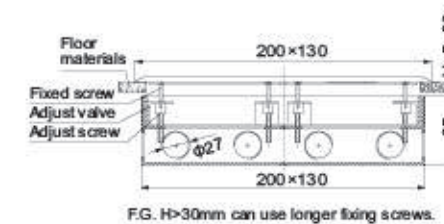

F.G. H>30mm can use longer fixing screws.



▲ Temporary lid Secure to box body during concrete pour to prevent ingress of slurry.

▲ Base box Ga-Steel box body: 200x130x65mm

OPENING AND CONCEALED FLOOR SOCKET

IGD-XBK6/K8,K6/K8,K3520 Floor Boxes Series

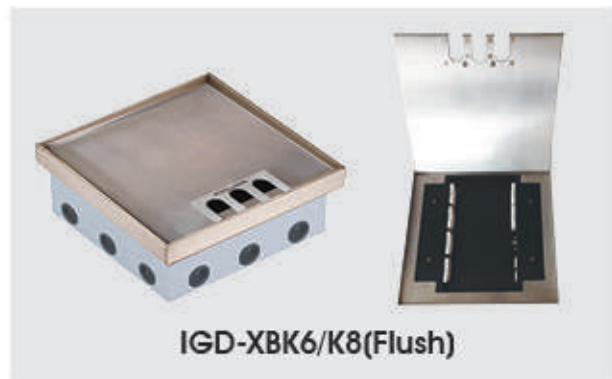

IGD-XBK6/K8(Flush)

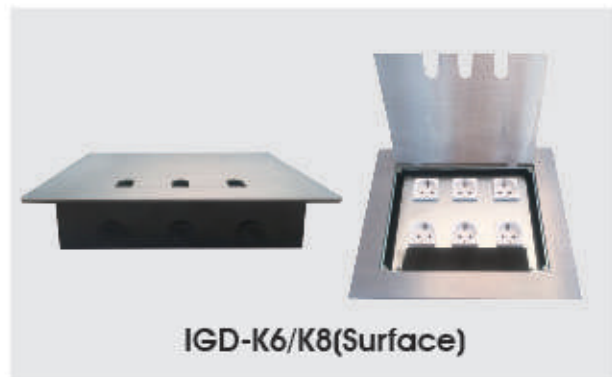

IGD-K6/K8(Surface)

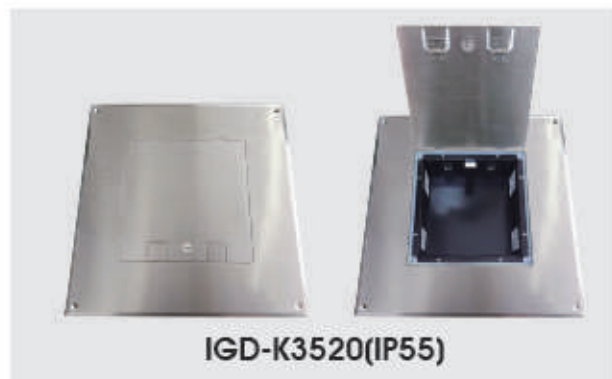

IGD-K3520(IP55)

Basic Parameter:

Panel Dimension:	(IGD-XBK6/K6)337.5 × 282mm (IGD-XBK8/K8)337.5 × 300mm (IGD-K3520)350 × 350mm
Panel Material:	Stainless-Steel
Finishing:	Wire drawing/Polishing / Spray painting
Interface size:	10 Modules
Bracket Material:	Zinc Alloy &Alu Alloy
Basebox material:	Steel+Zinc plated

◆ For special requirements & OEM/ODM service, please consult us.

Product specifications:

Part Number	Panel Material	Open style
IGD-XBK6/K8	Stainless-Steel	Open cover
IGD-K6/K8		
IGD-K3520		

Available sockets:

45 Type

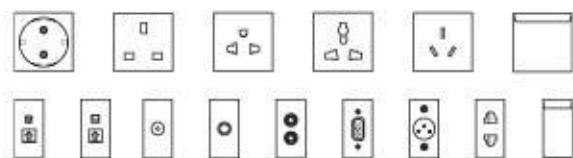

118 Type



Outline Drawing:

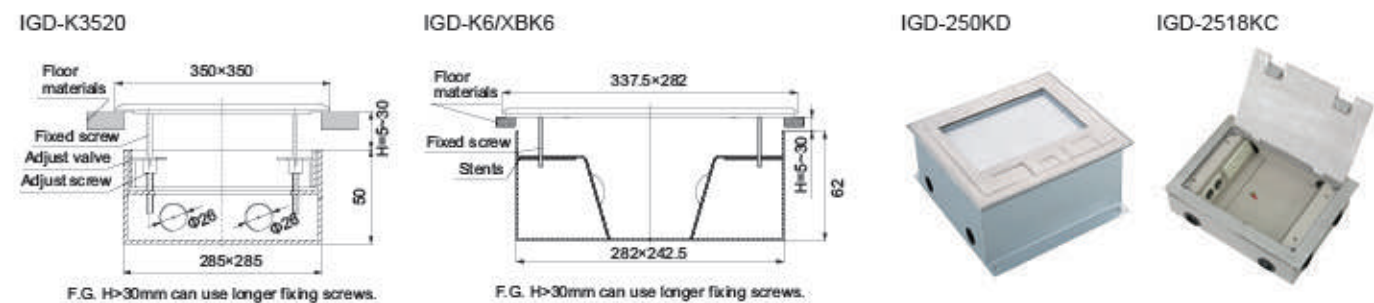

# PLASTIC TYPE FLOOR SOCKET





**PLASTIC TYPE FLOOR SOCKET**

**ITD-622AS,624AS Floor Boxes Series**



**Basic Parameter:**

Panel Dimension:	(ITD-622AS)169x141.5mm (ITD-624AS)245x225mm
Basebox Dimension:	(ITD-622AS)126x110.5x70mm (ITD-624AS)189.5x189.5x70mm
Panel Material:	Plastic
Interface size:	(ITD-622AS)8 Modules (ITD-624AS)12 Modules
Basebox material:	Plastic

◆ For special requirements & OEM/ODM service, please consult us.



**Available sockets:**

45 Type

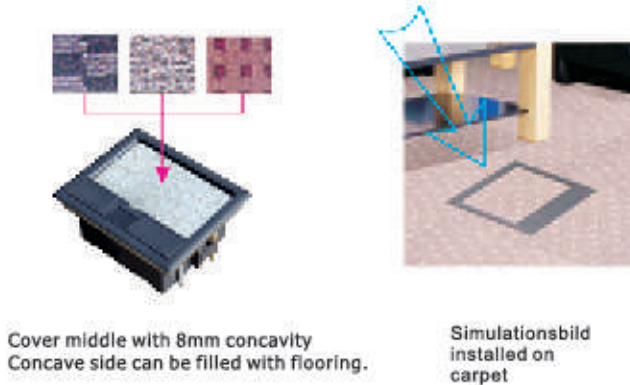
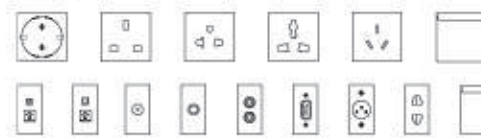

**Outline Drawing:**

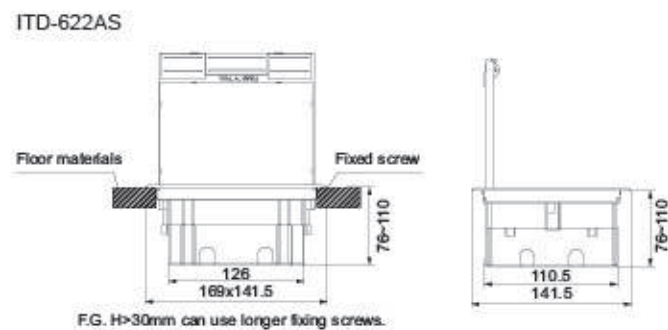

**PLASTIC TYPE FLOOR SOCKET**

**ITD-626AS,ITD-628AS Floor Boxes Series**



**Basic Parameter:**

Panel Dimension:	(ITD-626AS)320.5x230.5mm (ITD-628AS)328x230.5mm
Basebox Dimension:	(ITD-626AS)303.5x213.5x98mm (ITD-628AS)279.5x189.5x95mm
Panel Material:	Plastic
Interface size:	16 Modules
Basebox material:	(ITD-626AS)Steel, (ITD-628AS)Plastic

◆ For special requirements & OEM/ODM service, please consult us.



**Available sockets:**

45 Type

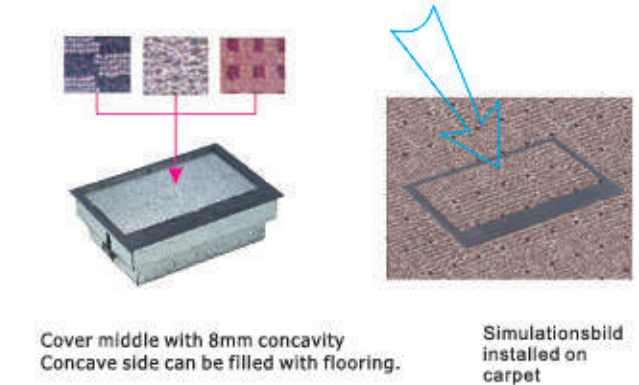
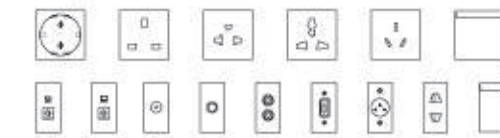

**Outline Drawing:**

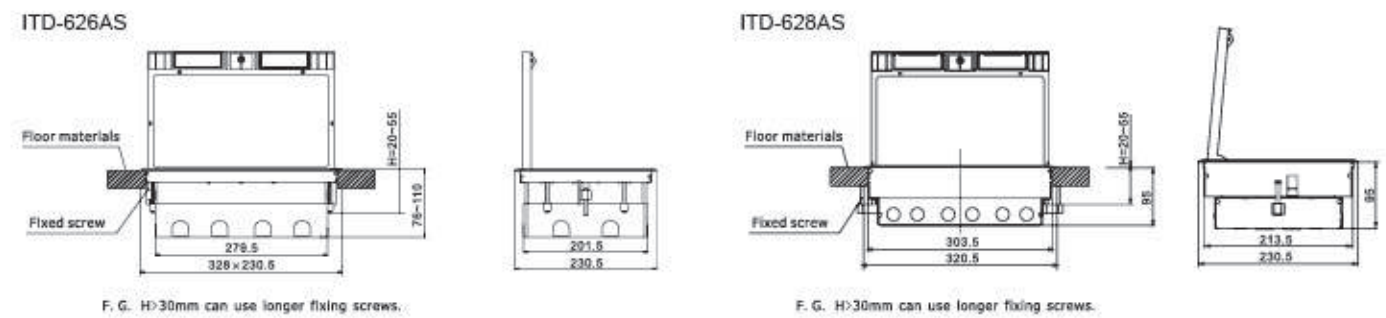

**CONCEPT TOWER SOCKET**

**IGZ531,IGZ532 Concept Tower Socket**



IGZ531A-D/IGZ531B-D



IGZ532A-D/IGZ532B-D

**Basic Parameter:**

Item No.:	Picture With Configuration	Configuration
IGZ531A-D		350mm Empty
IGZ531B-D		660mm Empty
IGZ532A-D		350mm Empty
IGZ532B-D		660mm Empty

**Available sockets:**

**45 Type**

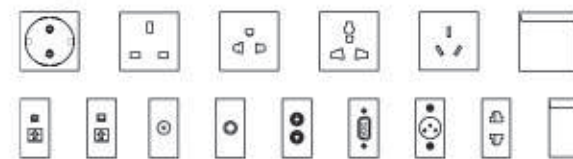

**118 Type**



**Outline Drawing:**

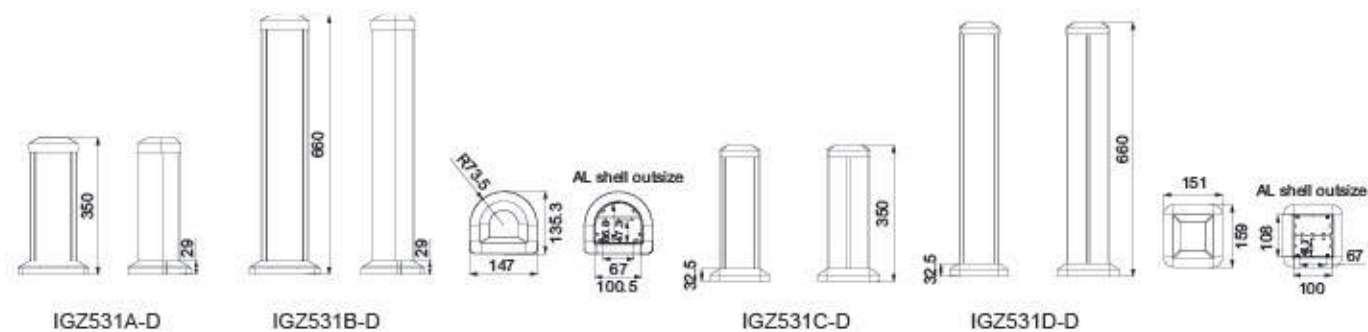

**MINI WARDROBE SOCKET**

**HGZN-D06 Mini Wardrobe Sockets**



**Product Description:**

HGZN-D06 Mini wardrobe sockets that The panel is made of aviation aluminum, the bottom box is made of PC environmental protection materials, the roller shutter type small flip cover is humanized design, it can be pushed up and down freely, the double lock buckle installation configuration is convenient and quick to install. Socket module can be freely replaced, the color can be customized according to customer requirements into black, silver,brown color.

**Basic Parameter:**

Item:	Concealed and hidden wall socket
Color:	Brown/silver
Model Number:	HGZN-D06
Brand Name:	iGERCN or EIH
Application:	Kitchen cabinet and wardrobe
Type:	Wall Socket
Grounding:	Standard Grounding
Rated Voltage:	250V/AC
Rated Current:	16A
Materials:	Aviation aluminum panel with PC box
Dimension:	86x86x5.5mm
Function:	Electrical Outlet Connection
Feature:	Easy Installation

**Available sockets:**

**45 Type**



**Outline Drawing:**

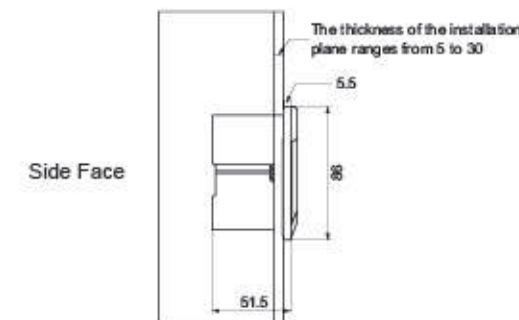

**Close State:**



**UNIVERSAL SOCKET**

**IG8668, IG8669 Universal Socket**



IG8668



IG8668



IG8669

**Specification:**

Brand Name:	IGERCN
Model Number:	IG8669
Usage:	Widely Used
Dimension:	Around 5.30x4.85x4.50cm
Product Material:	ABS + Copper
Product Inside:	Brass(Copper Bar) Internal Connection
Wattaggio:	1000 watt
Voltaggio:	250 Volt
Rated Current:	10A-16A
Certificate:	CE, FCC
Product Weight:	Around 32g
Colour:	Grey and White/ Full White
LOGO:	OEM, As your request

**OEM & ODM Order is Acceptable:**

- LOGO Customized
- Packing Customized
- Product OEM ODM



**FUNCTION ACCESSORIES**

**45 Type Function Accessories**

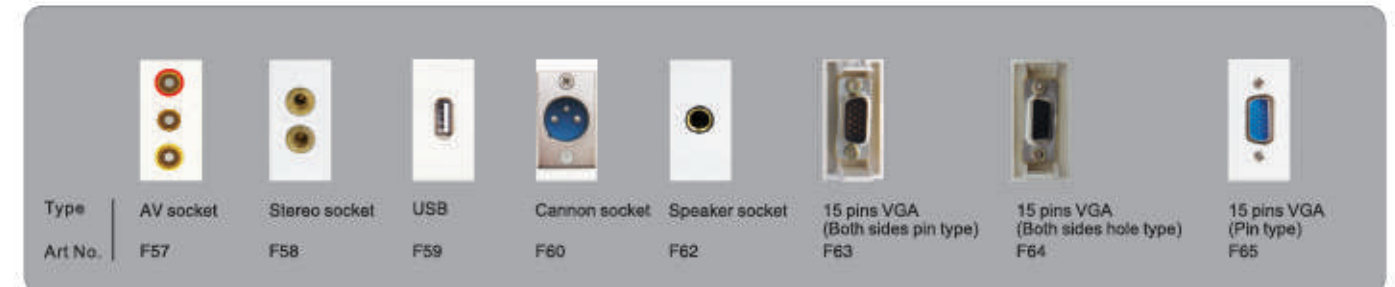
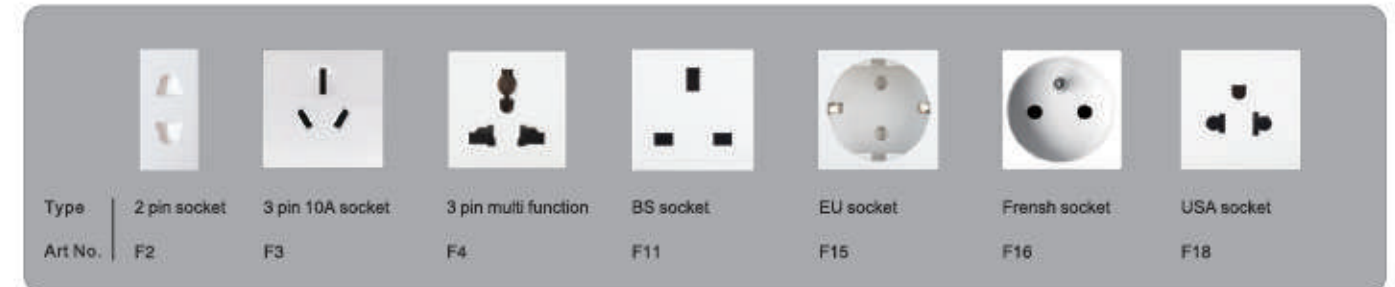

### 118 Type Sockets(36x36mm)

Type   2 pin socket	3 pin socket	3 pin multifactorial socket	3 phase 4 wires 16A socket	RJ45 socket	Cat.6 data socket
Art No.   B2	B3	B4	B5	B21	B22

Type   TEL socket	TV socket	BNC socket	Φ3.5 earphone socket	DIN (8 pins)	Audio socket
Art No.   B23	B50	B51	B52	B53	B55

Type   Video socket	Stereo socket	USB socket	Cannon socket (Pin type)	Cannon socket (Hole type)	Speaker socket
Art No.   B56	B58	B59	B60	B61	B62

Type   15 pins VGA (Both sides pin type)	15 pins VGA (Both sides hole type)	15 pins VGA (Pin type)	15 pins VGA (Hole type)	9 pins VGA (Pin type)	9 pins VGA (Hole type)
Art No.   B63	B64	B65	B66	B67	B68

Type   Twin audio socket	Empty plate	S-terminal	Stage stereo
Art No.   B69	B70	B71	B72



### IGER ELECTRIC

Our products are not only popular in the domestic market, but also exported to all over the world. No matter where you are, we can provide you with high quality, safe and reliable ground insertion solutions.



#### Pre-sale service

Provide specialized technical consulting & perfect solution to customers

#### In-sale service

Strictly supervise the each production link to ensure that the product is perfection

#### After-sales service

Reply of all technical inquiries of operate on time to ensure customer safety used