

# Professional Design WeatherProof Socket Switch



**iGERCN**<sup>®</sup>

YUEQING IGER ELECTRIC CO.,LTD.

Add: Room 303,building No.1,Unit 2,shanglaiqiao  
material decoration Area,liushi, Yueqing,Zhejiang,China 325604.

Factory: ShangmiAo,zndustrial zone,Yueqing  
Zhejiang,China 325604

Tel: +86-577-62731309

Fax: +86-577-27875953

MT: 13968771068

E-mail:sales@igercn.com

Skype:juanlia.iger

www.igercn.com



**iGERCN**<sup>®</sup>

**iGERCN**<sup>®</sup>

*Gold brick quality,  
professional service, choice iger!*



*Juanita*

86-577-62731309  
www.iger.cn.com

**WeatherProof Socket & Switch**  
Professional Design

## COMPANY PROFILE



YUEQING IGER ELECTRIC CO.,LTD is a professional manufacturer of intelligent socket And floor socket, intelligent timer and waterproof wall socket and switch in Zhejiang china more than 10years. Our products have been get the CE, ROHS, EESS, SAA, IK08, GCC, Qmark, EAC And 80% products have been exported to USA and European and Australia and South Asia Markets since 2010..

For many years our company have been improvement and innovation continuously on production manage system and quality control , and there Are more than 20 patent of invention and china exclusive patent for floor socket and intelligent socket was get.

The quality is our culture, with us your business is safe and successful. And OEM and ODM And OBM is supply for famous and strong company from the worldwide. You are welcome to Cooperate with us.



## WORKSHOP



## EXHIBITION



Guangzhou Electrical Building Technology  
And The Hannover Messer Exhibition And  
USA Smart Home Exhibition

# IP55 WEATHERPROOF WALL SWITCH & SOCKET

## Elabrate Design

THE 90° opening angle is convenient for various piugs.

## First Class Material

Switch selects the German high quality PC material.

## High Durability

PVC soft film will not harden within 2 years use.

## High Quality Copper

Contacts, made of high quality brass by one-batch forming, has good conductive performance.



**IGERCN**<sup>®</sup>

## IP55 Weatherproof Wall Switch & Socket

### Electric Vehicle Dedicated Charging Socket Series ( Automatic Power off When Fully Charging )



◆ 1Gang Socket 16A/110~250V~



◆ 1Gang Socket 16A/110~250V~



◆ 1Gang Socket 16A/110~250V~



◆ 1Gang Socket 16A/110~250V~



◆ 1Gang Socket 16A/110~250V~



◆ 1Gang Socket 16A/110~250V~

### Outline Drawing

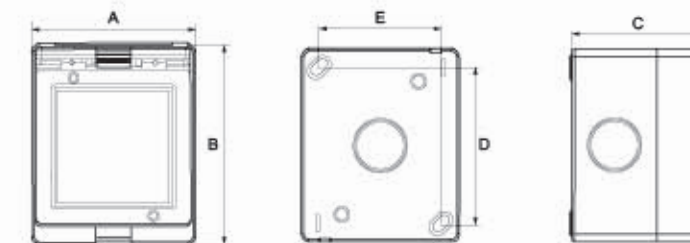

Type	A(mm)	B(mm)	C(mm)	D(mm)	E(mm)	Rated voltage	Level of protection:	Casting material
IG55A-AM	70	85	63	70	54	16A/110~250V~	IP55	ABS/PC
IG55A-AU	70	85	63	70	54	16A/110~250V~	IP55	ABS/PC
IG55A-BZ	70	85	63	70	54	16A/110~250V~	IP55	ABS/PC
IG55A-FH	70	85	63	70	54	16A/110~250V~	IP55	ABS/PC
IG55A-FR	70	85	63	70	54	16A/110~250V~	IP55	ABS/PC
IG55A-I	70	85	63	70	54	16A/110~250V~	IP55	ABS/PC

**IP55 Weatherproof Wall Switch & Socket**

**Electric Vehicle Dedicated Charging Socket Series  
( Automatic Power off When Fully Charging )**



◆ 1Gang Socket 16A/110~250V~



◆ 1Gang Socket 13A/110~250V~



◆ 1Gang Socket 16A/110~250V~



◆ 1Gang Socket 16A/110~250V~



◆ 1Gang Socket 16A/110~250V~

**Outline Drawing**

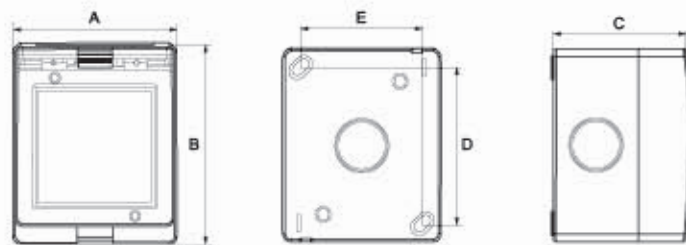

Type	A(mm)	B(mm)	C(mm)	D(mm)	E(mm)	Rated voltage	Level of protection:	Casting material
IG55A-L	70	85	63	70	54	16A/110~250V~	IP55	ABS/PC
IG55A-S	70	85	63	70	54	13A/110~250V~	IP55	ABS/PC
IG55A-SA	70	85	63	70	54	16A/110~250V~	IP55	ABS/PC
IG55A-SR	70	85	63	70	54	16A/110~250V~	IP55	ABS/PC
IG55A-U	70	85	63	70	54	16A/110~250V~	IP55	ABS/PC

**IP55 Weatherproof Wall Switch & Socket**

**Wall Switch Series**



◆ 1Gang Switch 16A/250V~



◆ 2Gang Switch 16A/250V~



◆ 4Gang Switch 16A/250V~



◆ 1Gang Bell Push Switch 16A/250V~



◆ 3Gang Switch 16A/250V~



◆ 6Gang Switch 16A/250V~

**Outline Drawing**

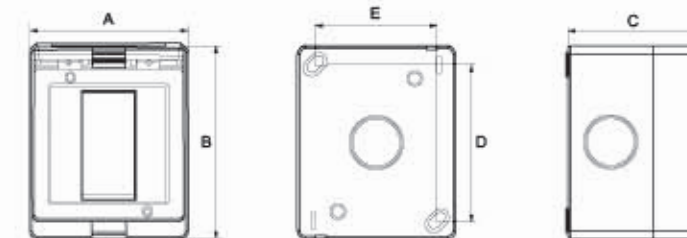

Type	A(mm)	B(mm)	C(mm)	D(mm)	E(mm)	Rated voltage	Level of protection:	Casting material
IG55-1GB	70	85	63	70	54	16A/250V~	IP55	ABS/PC
IG55-1GS	70	85	63	70	54	16A/250V~	IP55	ABS/PC
IG55-2GS	70	85	63	70	54	16A/250V~	IP55	ABS/PC
IG55-3GS	94	85	63	70	78	16A/250V~	IP55	ABS/PC
IG55-4GS	118	85	63	70	102	16A/250V~	IP55	ABS/PC
IG55-6GS	188	85	63	70	172	16A/250V~	IP55	ABS/PC

**IP55 Weatherproof Wall Switch & Socket**

**International Five Holes Series**



◆ 1Gang Socket 10A/250V~



◆ 2Gang Socket 10A/250V~



◆ 2Gang Switch 2Gang Socket 10A/250V~



◆ 1Gang Switch Socket 10A/250V~



◆ 3Gang Switch 16A/250V~



◆ 4Gang Switch 1Gang Socket 10A/250V~

**Outline Drawing**

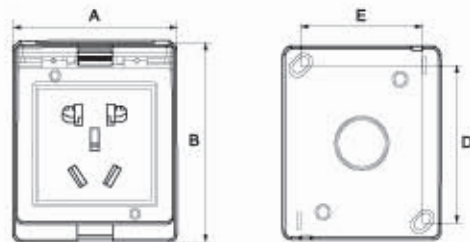

Type	A(mm)	B(mm)	C(mm)	D(mm)	E(mm)	Rated voltage	Level of protection:	Casting material
IG55-FH	70	85	63	70	54	10A/250V~	IP55	ABS/PC
IG55-FHS	94	85	63	70	78	10A/250V~	IP55	ABS/PC
IG55-2FH	118	85	63	70	102	10A/250V~	IP55	ABS/PC
IG55-FH2S	118	85	63	70	102	10A/250V~	IP55	ABS/PC
IG55-2FHS	188	85	63	70	172	10A/250V~	IP55	ABS/PC
IG55-FH4S	188	85	63	70	172	10A/250V~	IP55	ABS/PC

**IP55 Weatherproof Wall Switch & Socket**

**Universal Wall Switch Series**



◆ 1Gang Socket 16A/250V~



◆ 2Gang Socket 16A/250V~



◆ 2Gang Switch 2Gang Socket 16A/250V~



◆ 1Gang Switch Socket 16A/250V~



◆ 2Gang Switch 1Gang Socket 16A/250V~



◆ 4Gang Switch 1Gang Socket 16A/250V~

**Outline Drawing**

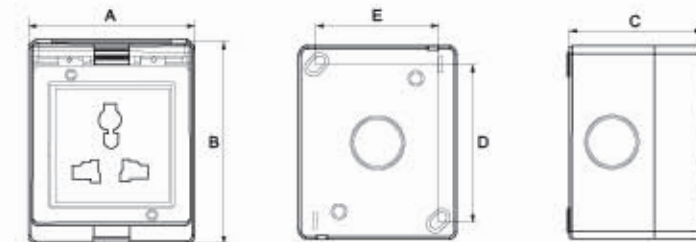

Type	A(mm)	B(mm)	C(mm)	D(mm)	E(mm)	Rated voltage	Level of protection:	Casting material
IG55-U	70	85	63	70	54	13A/250V~	IP55	ABS/PC
IG55-US	94	85	63	70	78	13A/250V~	IP55	ABS/PC
IG55-2U	118	85	63	70	102	13A/250V~	IP55	ABS/PC
IG55-U2S	118	85	63	70	102	13A/250V~	IP55	ABS/PC
IG55-2US	188	85	63	70	172	13A/250V~	IP55	ABS/PC
IG55-U4S	188	85	63	70	172	13A/250V~	IP55	ABS/PC

**IP55 Weatherproof Wall Switch & Socket**

**Germany Wall Switch Series**



**Outline Drawing**

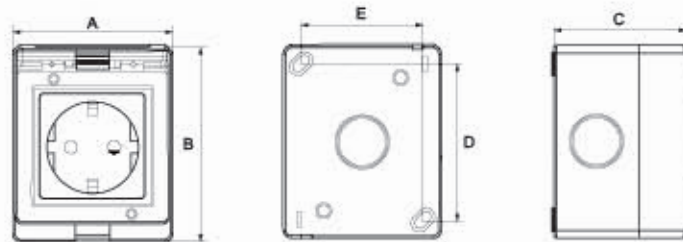

Type	A(mm)	B(mm)	C(mm)	D(mm)	E(mm)	Rated voltage	Level of protection:	Casting material
IG55-SR	70	85	63	70	54	16A/250V~	IP55	ABS/PC
IG55-SRS	94	85	63	70	78	16A/250V~	IP55	ABS/PC
IG55-2SR	118	85	63	70	102	16A/250V~	IP55	ABS/PC
IG55-SR2S	118	85	63	70	102	16A/250V~	IP55	ABS/PC
IG55-2SRS	188	85	63	70	172	16A/250V~	IP55	ABS/PC
IG55-SR4S	188	85	63	70	172	16A/250V~	IP55	ABS/PC

**IP55 Weatherproof Wall Switch & Socket**

**French Wall Switch Series**



**Outline Drawing**

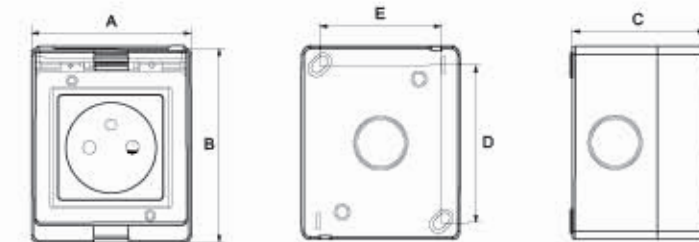

Type	A(mm)	B(mm)	C(mm)	D(mm)	E(mm)	Rated voltage	Level of protection:	Casting material
IG55-FR	70	85	63	70	54	16A/250V~	IP55	ABS/PC
IG55-FRS	94	85	63	70	78	16A/250V~	IP55	ABS/PC
IG55-2FR	118	85	63	70	102	16A/250V~	IP55	ABS/PC
IG55-FR2S	118	85	63	70	102	16A/250V~	IP55	ABS/PC
IG55-2FRS	188	85	63	70	172	16A/250V~	IP55	ABS/PC
IG55-FR4S	188	85	63	70	172	16A/250V~	IP55	ABS/PC

**IP55 Weatherproof Wall Switch & Socket**

**British Wall Switch Series**



**Outline Drawing**

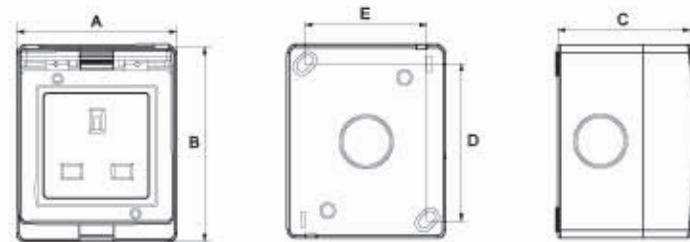

Type	A(mm)	B(mm)	C(mm)	D(mm)	E(mm)	Rated voltage	Level of protection:	Casting material
IG55-S	70	85	63	70	54	13A/250V~	IP55	ABS/PC
IG55-SS	94	85	63	70	78	13A/250V~	IP55	ABS/PC
IG55-2S	118	85	63	70	102	13A/250V~	IP55	ABS/PC
IG55-S2S	118	85	63	70	102	13A/250V~	IP55	ABS/PC
IG55-2SS	188	85	63	70	172	13A/250V~	IP55	ABS/PC
IG55-S4S	188	85	63	70	172	13A/250V~	IP55	ABS/PC

**IP55 Weatherproof Wall Switch & Socket**

**SA Wall Switch Series**



**Outline Drawing**

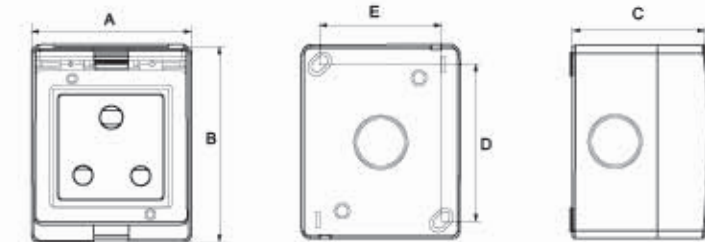

Type	A(mm)	B(mm)	C(mm)	D(mm)	E(mm)	Rated voltage	Level of protection:	Casting material
IG55-SA	70	85	63	70	54	16A/250V~	IP55	ABS/PC
IG55-SAS	94	85	63	70	78	16A/250V~	IP55	ABS/PC
IG55-2SA	118	85	63	70	102	16A/250V~	IP55	ABS/PC
IG55-SA2S	118	85	63	70	102	16A/250V~	IP55	ABS/PC
IG55-2SAS	188	85	63	70	172	16A/250V~	IP55	ABS/PC
IG55-SA4S	188	85	63	70	172	16A/250V~	IP55	ABS/PC



**IP55 Weatherproof Wall Switch & Socket**

**USA Wall Switch Series**



**Outline Drawing**

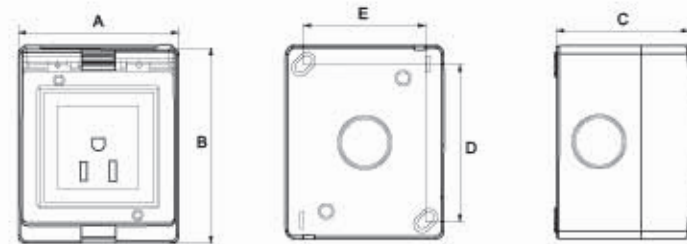

Type	A(mm)	B(mm)	C(mm)	D(mm)	E(mm)	Rated voltage	Level of protection:	Casting material
IG55-AM	70	85	63	70	54	10A/250V~	IP55	ABS/PC
IG55-AMS	94	85	63	70	78	10A/250V~	IP55	ABS/PC
IG55-2AM	118	85	63	70	102	10A/250V~	IP55	ABS/PC
IG55-AM2S	118	85	63	70	102	10A/250V~	IP55	ABS/PC
IG55-2AMS	188	85	63	70	172	10A/250V~	IP55	ABS/PC
IG55-AM4S	188	85	63	70	172	10A/250V~	IP55	ABS/PC

**IP55 Weatherproof Wall Switch & Socket**

**Three Phase Wall Switch Series**



**Outline Drawing**

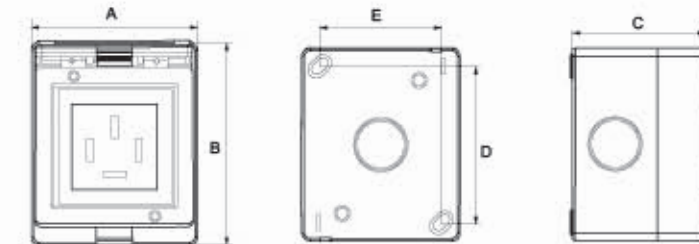

Type	A(mm)	B(mm)	C(mm)	D(mm)	E(mm)	Rated voltage	Level of protection:	Casting material
IG55-TP	70	85	63	70	54	16A/250V~	IP55	ABS/PC
IG55-TPS	94	85	63	70	78	16A/250V~	IP55	ABS/PC
IG55-2TP	118	85	63	70	102	16A/250V~	IP55	ABS/PC
IG55-TP2S	118	85	63	70	102	16A/250V~	IP55	ABS/PC
IG55-2TPS	188	85	63	70	172	16A/250V~	IP55	ABS/PC
IG55-TP4S	188	85	63	70	172	16A/250V~	IP55	ABS/PC

IP55 Weatherproof Wall Switch & Socket

Italy Wall Switch Series



◆ 1Gang Socket 16A/250V~



◆ 2Gang Socket 16A/250V~



◆ 1Gang Switch Socket 16A/250V~



◆ 2Gang switch Socket 16A/250V~



◆ 2Gang Socket switch 16A/250V~



◆ 3Gang Socket 16A/250V~

Outline Drawing

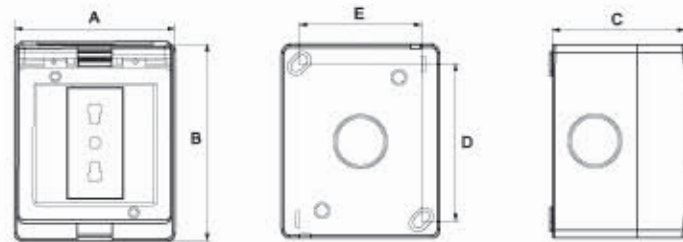

Type	A(mm)	B(mm)	C(mm)	D(mm)	E(mm)	Rated voltage	Level of protection:	Casting material
IG55-1C	70	85	63	70	54	16A/250V~	IP55	ABS/PC
IG55-2C	70	85	63	70	54	16A/250V~	IP55	ABS/PC
IG55-1CS	70	85	63	70	54	16A/250V~	IP55	ABS/PC
IG55-C2S	94	85	63	70	78	16A/250V~	IP55	ABS/PC
IG55-2CS	94	85	63	70	78	16A/250V~	IP55	ABS/PC
IG55-3C	94	85	63	70	78	16A/250V~	IP55	ABS/PC

# IP66 SERIES

## Weatherproof Socket&Switch



(IP66) One Weatherproof Switch Socket Series

IG66-SR, IG66-S



IG66-SR



IG66-2I



IG66-S

Basic Parameter:

Rated voltage:	IG66-SR(16A-250V~) IG66-S(13A-250V~)
Level of protection:	IP66
Dimension:	100 × 100 × 73mm
Interface size:	1 Module
Casting material:	ABS/PC

◆ For special requirements & OEM/ODM service, please consult us.

Available sockets:



Outline Drawing

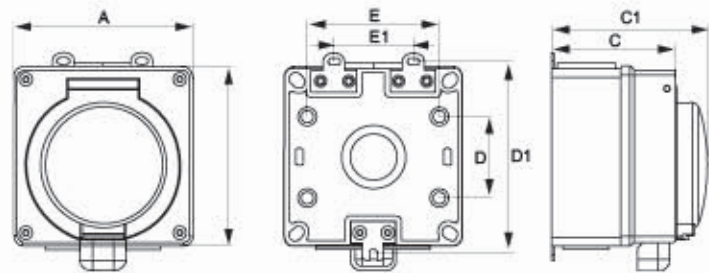

Type	A(mm)	B(mm)	C(mm)	D(mm)	E(mm)	C1 (mm)	D1(mm)	E1 (mm)
IG66-SR	100	100	73	45	74	90	107	44
IG66-S	100	100	73	45	74	90	107	44

(IP66) Two Weatherproof Switch Socket Series

IG66-2SR, IG66-2U, IG66-2S



IG66-2SR



IG66-2U



IG66-2S

Basic Parameter:

Rated voltage:	IG66-2SR(16A-250V~) IG66-2U(13A-250V~) IG66-2S(13A-250V~)
Level of protection:	IP66
Dimension:	100 × 200 × 73mm
Interface size:	2 Modules
Casting material:	ABS/PC

◆ For special requirements & OEM/ODM service, please consult us.

Available sockets:



Outline Drawing

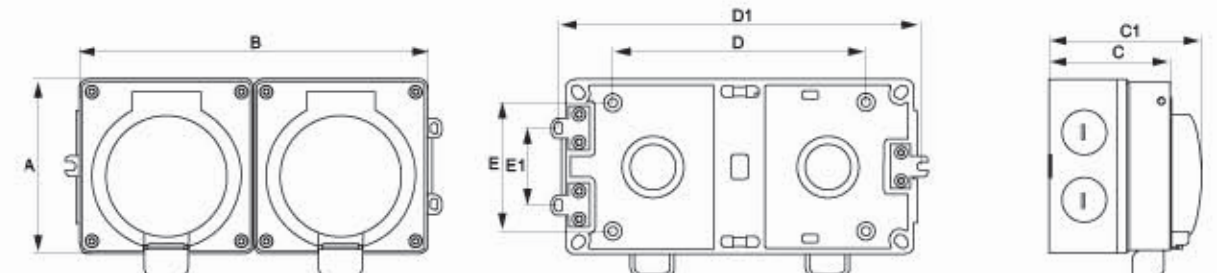

Type	A(mm)	B(mm)	C(mm)	D(mm)	E(mm)	C1 (mm)	D1(mm)	E1 (mm)
IG66-2SR	100	200	73	145	74	90	208	44
IG66-2U	100	200	73	145	74	90	208	44
IG66-2S	100	200	73	145	74	90	208	44

**(IP66) Two Weatherproof Switch Socket Series**

**IG66-SS, IG66-US, IG66-FRS**



IG66-SS



IG66-US



IG66-FRS

**Basic Parameter:**

Rated voltage:	IG66-SS(13A-250V~) IG66-US(13A-250V~) IG66-FRS(16A-250V~)
Level of protection:	IP66
Dimension:	100 × 200 × 73mm
Interface size:	2 Modules
Casting material:	ABS/PC

◆ For special requirements & OEM/ODM service, please consult us.

**Available sockets:**



**Outline Drawing**

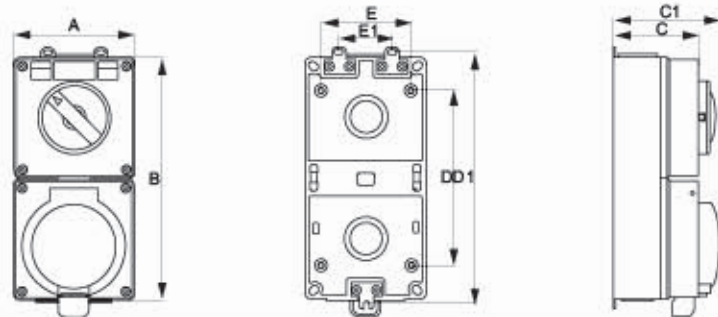

Type	A(mm)	B(mm)	C(mm)	D(mm)	E(mm)	C1 (mm)	D1(mm)	E1 (mm)
IG66-SS	100	200	73	145	74	90	208	44
IG66-US	100	200	73	145	74	90	208	44
IG66-FRS	100	200	73	145	74	90	208	44

**(IP66) Three Weatherproof Switch Socket Series**

**IG66-S2SR, IG66-S2U, IG66-S2S**



IG66-S2SR



IG66-S2U



IG66-S2S

**Basic Parameter:**

Rated voltage:	IG66-S2SR(16A-250V~) IG66-S2U(13A-250V~) IG66-S2S(13A-250V~)
Level of protection:	IP66
Dimension:	100 × 300 × 73mm
Interface size:	3 Modules
Casting material:	ABS/PC

◆ For special requirements & OEM/ODM service, please consult us.

**Available sockets:**



**Outline Drawing**

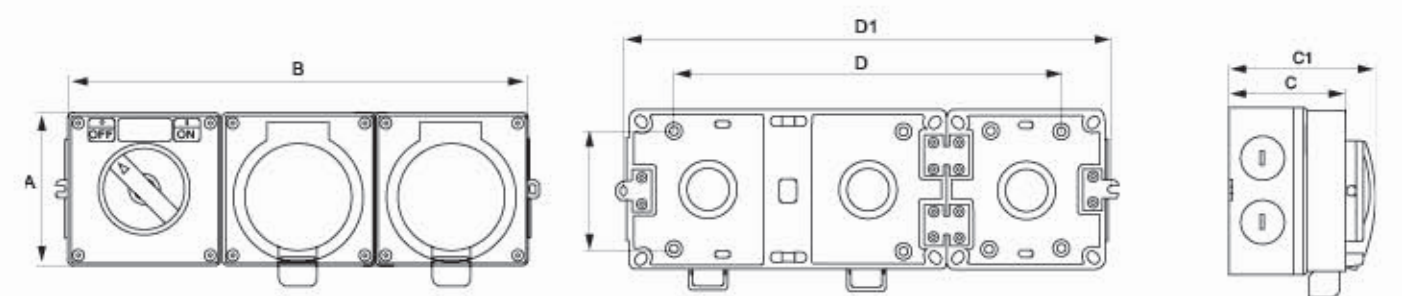

Type	A(mm)	B(mm)	C(mm)	D(mm)	E(mm)	C1 (mm)	D1(mm)
IG66-S2SR	100	300	73	245	74	90	308
IG66-S2U	100	300	73	245	74	90	308
IG66-S2S	100	300	73	245	74	90	308

(IP66) Four Weatherproof switch socket series

IG66-S3S, IG66-S3U, IG66-S3FR



IG66-S3S



IG66-S3U



IG66-S3FR

Basic Parameter:

Rated voltage:	IG66-S3S(13A-250V~) IG66-S3U(13A-250V~) IG66-S3FR(16A-250V~)
Level of protection:	IP66
Dimension:	100 × 400 × 73mm
Interface size:	4 Modules
Casting material:	ABS/PC

◆ For special requirements & OEM/ODM service, please consult us.

Available sockets:



Outline Drawing

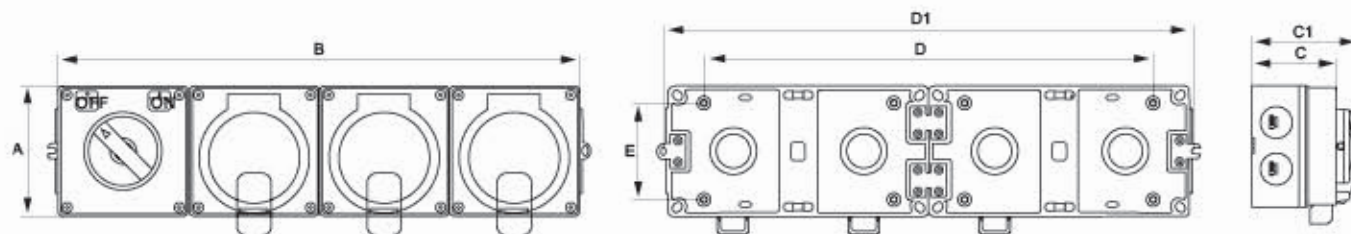

Type	A(mm)	B(mm)	C(mm)	D(mm)	E(mm)	C1 (mm)	D1(mm)
IG66-S3S	100	400	73	346	74	90	408
IG66-S3U	100	400	73	346	74	90	408
IG66-S3FR	100	400	73	346	74	90	408

(IP66) One Weatherproof Switch Socket Series

IGX66-S2SR, IGX66-U, IGX66-S2S



IGX66-SR



IGX66-U



IGX66-S

Basic Parameter:

Rated voltage:	IGX66-SR(16A-250V~) IGX66-U(13A-250V~) IGX66-S(13A-250V~)
Level of protection:	IP66
Dimension:	140 × 100 × 73mm
Interface size:	1 Modules
Casting material:	ABS/PC

◆ For special requirements & OEM/ODM service, please consult us.

Available sockets:



Outline Drawing

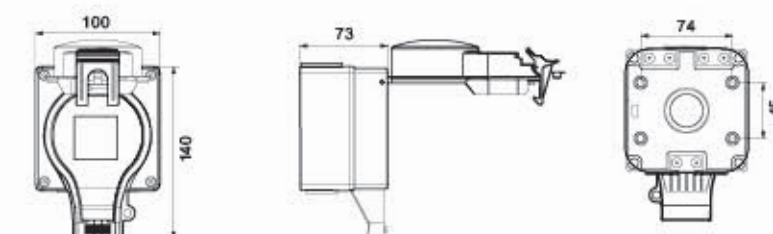

Type	A(mm)	B(mm)	C(mm)	D(mm)	E(mm)
IGX66-SR	140	100	73	74	45
IGX66-U	140	100	73	74	45
IGX66-S	140	100	73	74	45

(IP66) One Weatherproof switch socket series

IGX66-AM, IGX66-FR, IGX66-FH



IGX66-AM



IGX66-FR



IGX66-2I

Basic Parameter:

Rated voltage:	IGX66-AM(16A-250V~) IGX66-FR(16A-250V~) IGX66-2I(10A-250V~)
Level of protection:	IP66
Dimension:	140 × 100 × 73mm
Interface size:	1 Modules
Casting material:	ABS/PC

◆ For special requirements & OEM/ODM service, please consult us.

Available sockets:



Outline Drawing

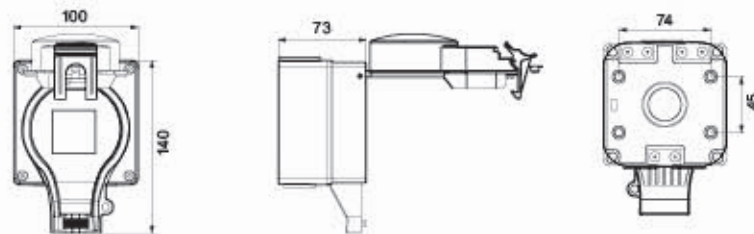

Type	A(mm)	B(mm)	C(mm)	D(mm)	E(mm)
IGX66-AM	140	100	73	74	45
IGX66-FR	140	100	73	74	45
IGX66-2I	140	100	73	74	45

(IP66) Two Weatherproof Switch Socket Series

IGX66-2SR, IGX66-2U, IGX66-2S



IGX66-2SR



IGX66-2U



IGX66-2S

Basic Parameter:

Rated voltage:	IGX66-2SR(16A-250V~) IGX66-2U(13A-250V~) IGX66-2S(13A-250V~)
Level of protection:	IP66
Dimension:	140 × 200 × 73mm
Interface size:	2 Modules
Casting material:	ABS/PC

◆ For special requirements & OEM/ODM service, please consult us.

Available sockets:



Outline Drawing

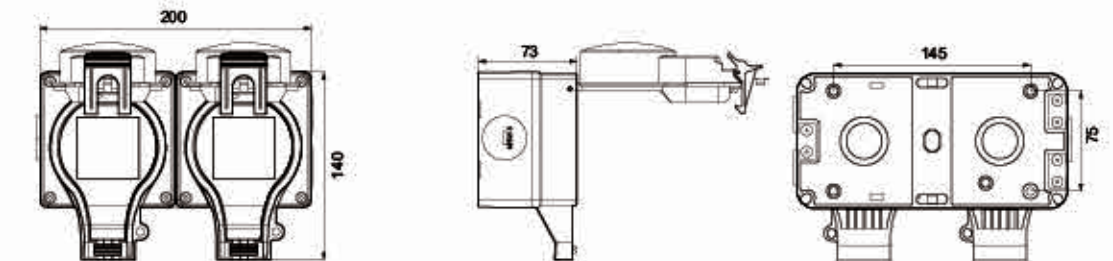

Type	A(mm)	B(mm)	C(mm)	D(mm)	E(mm)
IGX66-2SR	140	200	73	145	74
IGX66-2U	140	200	73	145	74
IGX66-2S	140	200	73	145	74

(IP66) Two Weatherproof switch socket series

IGX66-2AM, IGX66-2FR, IGX66-2FH



IGX66-2AM



IGX66-2FR



IGX66-2FH

Basic Parameter:

Rated voltage:	IGX66-2AM(13A-250V~) IGX66-2FR(13A-250V~) IGX66-2FH(16A-250V~)
Level of protection:	IP66
Dimension:	140 × 200 × 73mm
Interface size:	2 Modules
Casting material:	ABS/PC

◆ For special requirements & OEM/ODM service, please consult us.

Available sockets:



Outline Drawing

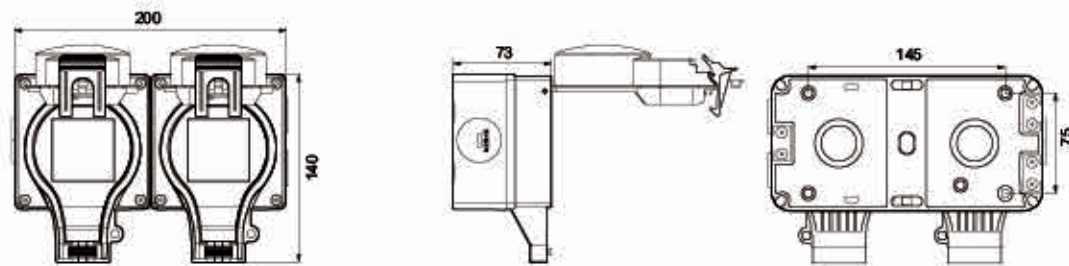

Type	A(mm)	B(mm)	C(mm)	D(mm)	E(mm)
IGX66-2AM	140	200	73	145	74
IGX66-2FR	140	200	73	145	74
IGX66-2FH	140	200	73	145	74

(IP66) Two Weatherproof Switch Socket Series

IGX66-SRS, IGX66-US, IGX66-SS



IGX66-SRS



IGX66-US



IGX66-SS

Basic Parameter:

Rated voltage:	IGX66-SRS(16A-250V~) IGX66-US(13A-250V~) IGX66-SS(13A-250V~)
Level of protection:	IP66
Dimension:	100 × 240 × 73mm
Interface size:	2 Modules
Casting material:	ABS/PC

◆ For special requirements & OEM/ODM service, please consult us.

Available sockets:



Outline Drawing

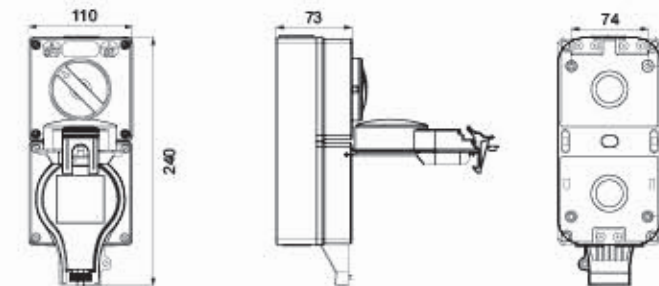

Type	A(mm)	B(mm)	C(mm)	D(mm)	E(mm)
IGX66-SRS	100	240	73	145	74
IGX66-US	100	240	73	145	74
IGX66-SS	100	240	73	145	74

**(IP66) Two Weatherproof Switch Socket Series**

**IGX66-AMS, IGX66-FRS**



IGX66-AMS



IGX66-FRS

**Basic Parameter:**

Rated voltage:	IGL66-AMS(16A-250V~) IGL66-FRS(16A-250V~)
Level of protection:	IP66
Dimension:	100 × 240 × 73mm
Interface size:	2 Module
Casting material:	ABS/PC

◆ For special requirements & OEM/ODM service, please consult us.

**Available sockets:**



**Outline Drawing**

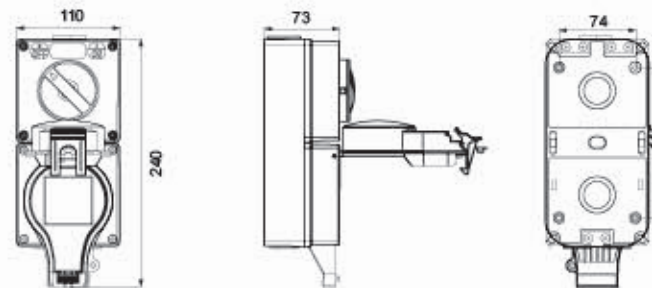

Type	A(mm)	B(mm)	C(mm)	D(mm)	E(mm)
IGX66-AMS	100	240	73	145	74
IGX66-FRS	100	240	73	145	74

**(IP66) Three Weatherproof Switch Socket Series**

**IGX66-S2SR, IGX66-S2U, IGX66-S2S**



IGX66-S2SR



IGX66-S2U



IGX66-S2S

**Basic Parameter:**

Rated voltage:	IGX66-S2SR(16A-250V~) IGX66-S2U(13A-250V~) IGX66-S2S(13A-250V~)
Level of protection:	IP66
Dimension:	140 × 300 × 73mm
Interface size:	3 Modules
Casting material:	ABS/PC

◆ For special requirements & OEM/ODM service, please consult us.

**Available sockets:**



**Outline Drawing**

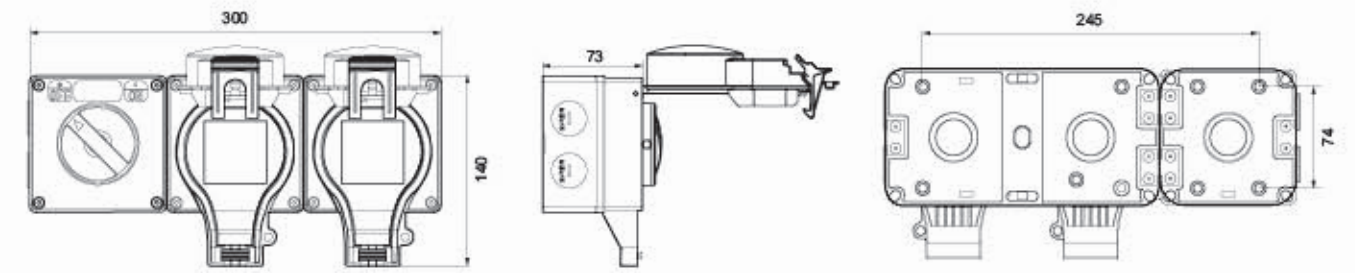

Type	A(mm)	B(mm)	C(mm)	D(mm)	E(mm)
IGX66-S2SR	140	300	73	245	74
IGX66-S2U	140	300	73	245	74
IGX66-S2S	140	300	73	245	74



(IP66) Four Weatherproof Switch Socket Series

IGX66-S2SR, IGX66-S2U, IGX66-S2S



IGX66-S3SR



IGX66-S3U



IGX66-S3S

Basic Parameter:

Rated voltage:	IGX66-S3SR(16A-250V~) IGX66-S3U(13A-250V~) IGX66-S3S(13A-250V~)
Level of protection:	IP66
Dimension:	100 × 300 × 73mm
Interface size:	3 Modules
Casting material:	ABS/PC

◆ For special requirements & OEM/ODM service, please consult us.

Available sockets:



Outline Drawing

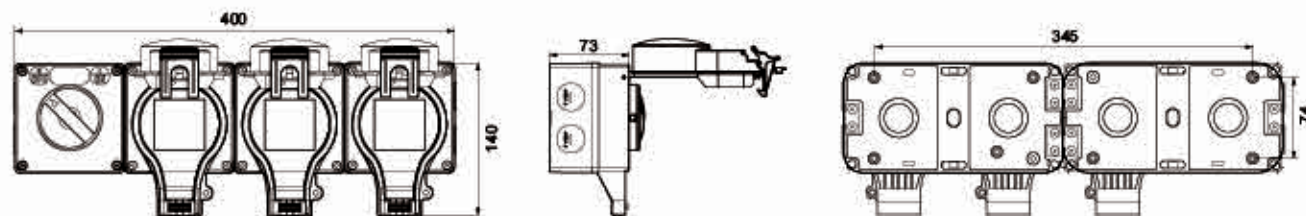

Type	A(mm)	B(mm)	C(mm)	D(mm)	E(mm)
IGX66-S3SR	140	400	73	345	74
IGX66-S3U	140	400	73	345	74
IGX66-S3S	140	400	73	345	74

WIFI SMART WEATHERPROOF WALL SOCKET

BENFIT YOU LIFE



Timing



APP Remote Control



Smart Lock



IP66 Waterproof Level



Material

(IP66) WIFI Smart Weatherproof Socket Series

IGW86-SS, IGW86-US, IGW86-FRS



Basic Parameter:

Rated voltage:	IGW86-SR(16A-250V~) IGW86-U(13A-250V~) IGW86-I(15A-250V~)
Level of protection:	IP66
Dimension:	110 × 170 × 110mm
Interface size:	1 Modules
Casting material:	ABS/PC

◆ For special requirements & OEM/ODM service, please consult us.

Available sockets:



Outline Drawing

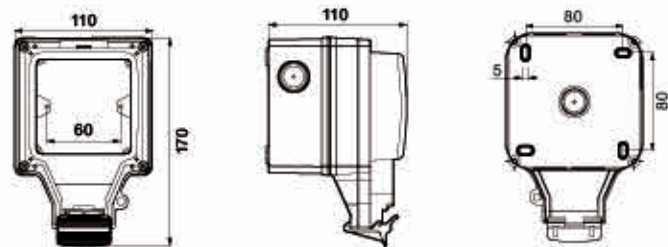

Type	A(mm)	B(mm)	C(mm)	D(mm)	E(mm)	C1 (mm)
IGW86-SR	110	170	110	60	80	80
IGW86-U	110	170	110	60	80	80
IGW86-I	110	170	110	60	80	80

(IP66) WIFI Smart Weatherproof Socket Series

IG86-SS, IG86-US, IG86-FRS



Basic Parameter:

Rated voltage:	IGW86-2SR(16A-250V~) IGW86-2U(13A-250V~)
Level of protection:	IP66
Dimension:	170 × 170 × 110mm
Interface size:	2 Module
Casting material:	ABS/PC

◆ For special requirements & OEM/ODM service, please consult us.

Available sockets:



Outline Drawing

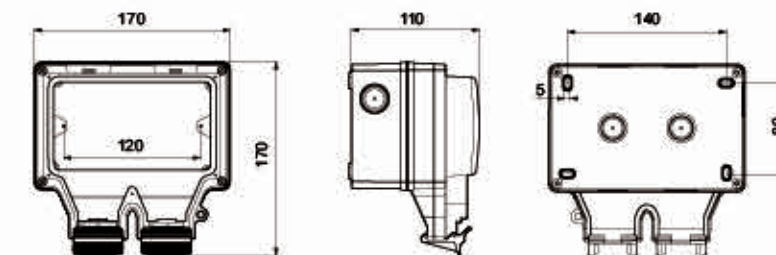

Type	A(mm)	B(mm)	C(mm)	D(mm)	E(mm)	C1 (mm)
IGW86-2SR	170	170	110	120	140	80
IGW86-2U	170	170	110	120	140	80

(IP66) One Gang Weatherproof Socket Series

IG86-SR, IG86-S, IG86-2I



IG86-SR



IG86-S



IG86-2I

Basic Parameter:

Rated voltage:	IG86-SR(16A-250V~) IG86-S(13A-250V~) IG86-2I(10A-250V~)
Level of protection:	IP66
Dimension:	110 × 170 × 110mm
Interface size:	1 Modules
Casting material:	ABS/PC

◆ For special requirements & OEM/ODM service, please consult us.

Available sockets:



Outline Drawing

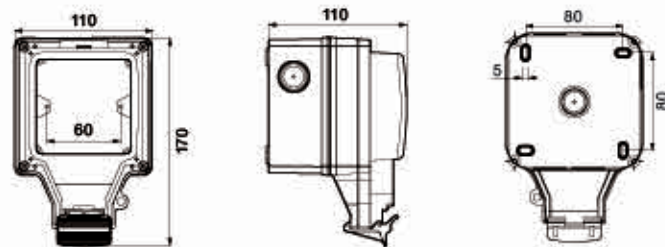

Type	A(mm)	B(mm)	C(mm)	D(mm)	E(mm)	C1 (mm)
IG86-SR	110	170	110	60	80	80
IG86-S	110	170	110	60	80	80
IG86-2I	110	170	110	60	80	80

(IP66) Two Gang Weatherproof Switch Socket Series

IG86-2SR, IG86-2U, IG86-2S



IG86-2SR



IG86-2U



IG86-2S

Basic Parameter:

Rated voltage:	IG86-2SR(16A-250V~) IG86-2U(13A-250V~) IG86-2S(10A-250V~)
Level of protection:	IP66
Dimension:	170 × 170 × 110mm
Interface size:	2 Module
Casting material:	ABS/PC

◆ For special requirements & OEM/ODM service, please consult us.

Available sockets:



Outline Drawing

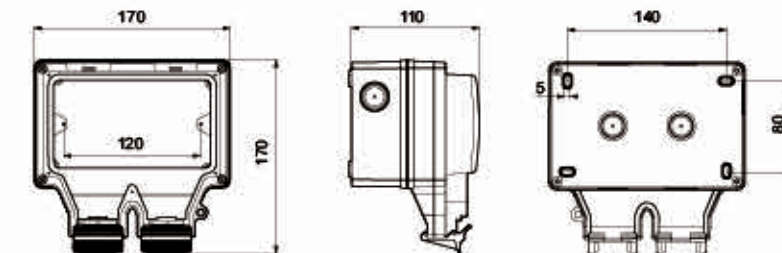

Type	A(mm)	B(mm)	C(mm)	D(mm)	E(mm)
IG86-2SR	170	170	100	140	80
IG86-2U	170	170	100	140	80
IG8wW6-2S	170	170	100	140	80

**(IP66) Two Gang Weatherproof Switch Socket Series**

**IG86-4S, IG86-2SS, IG86-4I**



**Basic Parameter:**

Rated voltage:	IG86-4S(16A-250V~) IG86-2SS(13A-250V~) IG86-4I(10A-250V~)
Level of protection:	IP66
Dimension:	170 × 170 × 110mm
Interface size:	4 Module
Casting material:	ABS/PC

◆ For special requirements & OEM/ODM service, please consult us.

**Available sockets:**



**Outline Drawing**

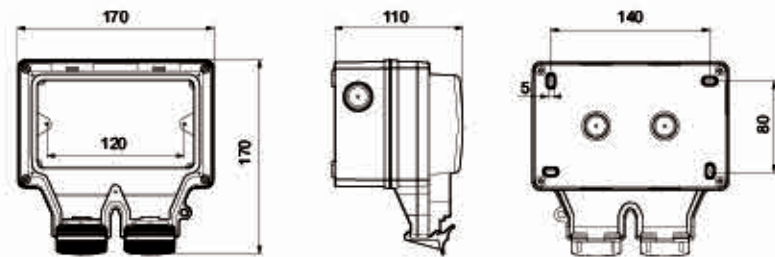

Type	A(mm)	B(mm)	C(mm)	D(mm)	E(mm)
IG86-4S	170	170	100	140	80
IG86-2SS	170	170	100	140	80
IG86-4I	170	170	100	140	80

**(IP66) One Gang Weatherproof Socket Series**

**Electric Vehicle Dedicated Charging Socket Series  
( Automatic Power off When Fully Charging )**



**Basic Parameter:**

Rated voltage:	10~16A-110~250V~
Level of protection:	IP66
Dimension:	110 × 170 × 110mm
Interface size:	1 Modules
Casting material:	ABS/PC

◆ For special requirements & OEM/ODM service, please consult us.

**Available sockets:**



**Outline Drawing**

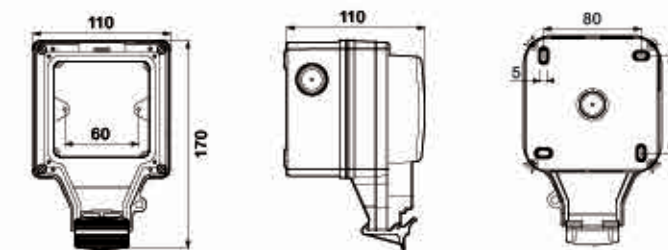

Type	A(mm)	B(mm)	C(mm)	D(mm)	E(mm)	C1 (mm)
IGW1-SR	110	170	110	60	80	80
IGW1-FR	110	170	110	60	80	80

(IP66) One Gang Weatherproof Socket Series

Electric Vehicle Dedicated Charging Socket Series  
( Automatic Power off When Fully Charging )



IGW1-AM

Basic Parameter:

Rated voltage:	IGW1-AM(16A-110~250V~) IGW1-AU(15A-110~250V~)
Level of protection:	IP66
Dimension:	110 × 170 × 110mm
Interface size:	1 Modules
Casting material:	ABS/PC

◆ For special requirements & OEM/ODM service, please consult us.



IGW1-AU

Available sockets:



Outline Drawing

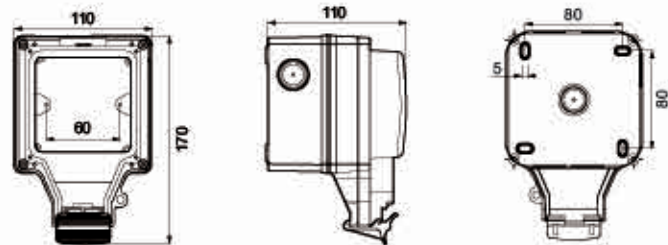

Type	A(mm)	B(mm)	C(mm)	D(mm)	E(mm)	C1 (mm)
IGW1-AM	110	170	110	60	80	80
IGW1-AU	110	170	110	60	80	80

(IP66) One Gang Weatherproof Socket Series

Electric Vehicle Dedicated Charging Socket Series  
( Automatic Power off When Fully Charging )



IGW1-U

Basic Parameter:

Rated voltage:	IGW1-U(16A-110~250V~) IGW1-S(13A-110~250V~)
Level of protection:	IP66
Dimension:	110 × 170 × 110mm
Interface size:	1 Modules
Casting material:	ABS/PC

◆ For special requirements & OEM/ODM service, please consult us.



IGW1-S

Available sockets:



Outline Drawing

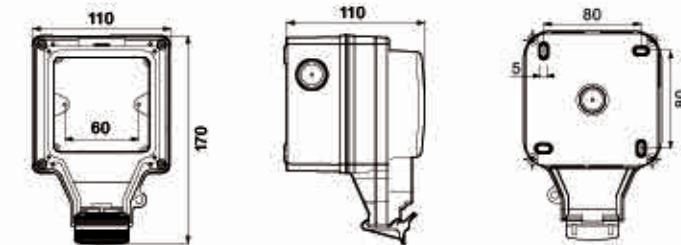

Type	A(mm)	B(mm)	C(mm)	D(mm)	E(mm)	C1 (mm)
IGW1-U	110	170	110	60	80	80
IGW1-S	110	170	110	60	80	80

**(IP66) One Gang Weatherproof Socket Series**

**Electric Vehicle Dedicated Charging Socket Series  
( Automatic Power off When Fully Charging )**



IGW1-I

**Basic Parameter:**

Rated voltage:	16A-110~250V~
Level of protection:	IP66
Dimension:	110 × 170 × 110mm
Interface size:	1 Modules
Casting material:	ABS/PC

◆ For special requirements & OEM/ODM service, please consult us.



IGW1-SA

**Available sockets:**



**Outline Drawing**

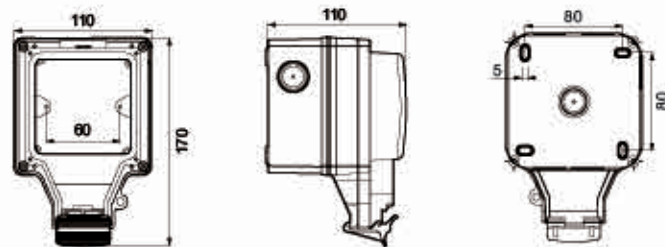

Type	A(mm)	B(mm)	C(mm)	D(mm)	E(mm)	C1 (mm)
IGW1-I	110	170	110	60	80	80
IGW1-SA	110	170	110	60	80	80

**(IP66) One /Two Gang Weatherproof Socket Series**

**IG5-15-1,IG5-15-2**



IG5-15-1

**Basic Parameter:**

Rated voltage:	15A-AC125V~
Level of protection:	IP66
Dimension:	IG5-15-1(110 × 170 × 110mm) IG5-15-2(170 × 170 × 110mm)
Interface size:	1 Modules
Casting material:	ABS/PC

◆ For special requirements & OEM/ODM service, please consult us.



IG5-15-2

**Available sockets:**



**Outline Drawing**

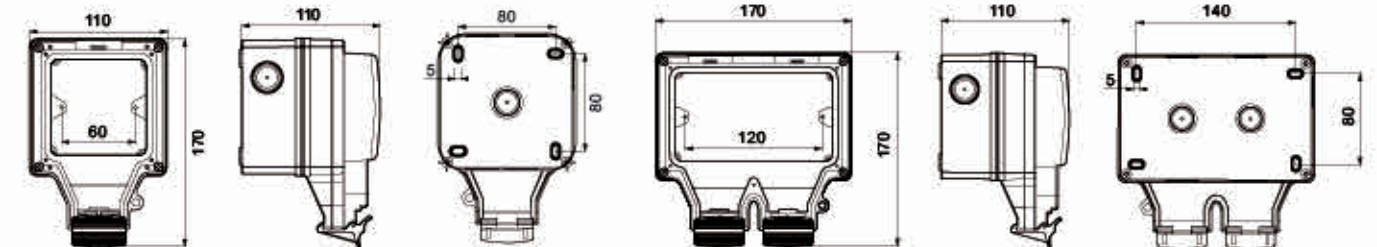

Type	A(mm)	B(mm)	C(mm)	D(mm)	E(mm)	C1 (mm)
IG5-15-1	110	170	110	60	80	80
IG5-15-2	170	170	100	140	80	80

**(IP66) One /Two Gang Weatherproof Socket Series**

**IG5-20R-1/2 New Energy Vehicle Charging Socket**



IG5-20R-1

**Basic Parameter:**

Rated voltage:	20A-AC125V~
Level of protection:	IP66
Dimension:	IG5-20R-1(110 × 170 × 110mm) IG5-20R-2(170 × 170 × 110mm)
Interface size:	1 Modules
Casting material:	ABS/PC

◆ For special requirements & OEM/ODM service, please consult us.



IG5-20R-2

**Available sockets:**



**Outline Drawing**

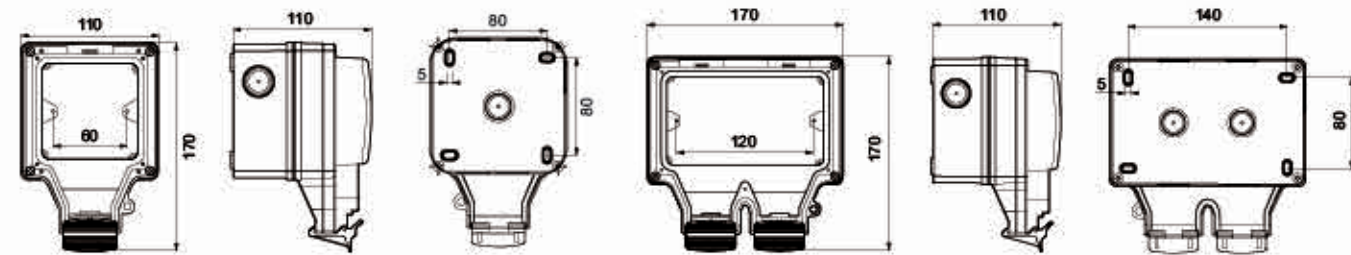

Type	A(mm)	B(mm)	C(mm)	D(mm)	E(mm)	C1 (mm)
IG5-20R-1	110	170	110	60	80	80
IG5-20R-2	170	170	100	140	80	80

**(IP66) Two Gang Weatherproof Socket Series**

**IG6-20R New Energy Vehicle Charging Socket**



**Basic Parameter:**

Rated voltage:	20A-AC125V~
Level of protection:	IP66
Dimension:	IG5-20R-1(110 × 170 × 110mm) IG5-20R-2(170 × 170 × 110mm)
Interface size:	1 Modules
Casting material:	ABS/PC

◆ For special requirements & OEM/ODM service, please consult us.



**Available sockets:**



**Outline Drawing**

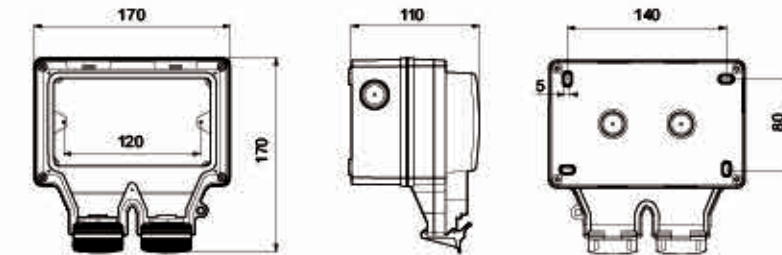

Type	A(mm)	B(mm)	C(mm)	D(mm)	E(mm)	C1 (mm)
IG5-20R	170	170	100	140	80	80

**(IP66) One /Two Gang Weatherproof Socket Series**

**IG5-30R-1/2 New Energy Vehicle Charging Socket**



IG5-30R-1

**Basic Parameter:**

Rated voltage:	30A-AC125V~
Level of protection:	IP66
Dimension:	IG5-30R-1(110 × 170 × 110mm) IG5-30R-2(170 × 170 × 110mm)
Interface size:	1 Modules
Casting material:	ABS/PC

◆ For special requirements & OEM/ODM service, please consult us.



IG5-30R-2

**Available sockets:**



**Outline Drawing**

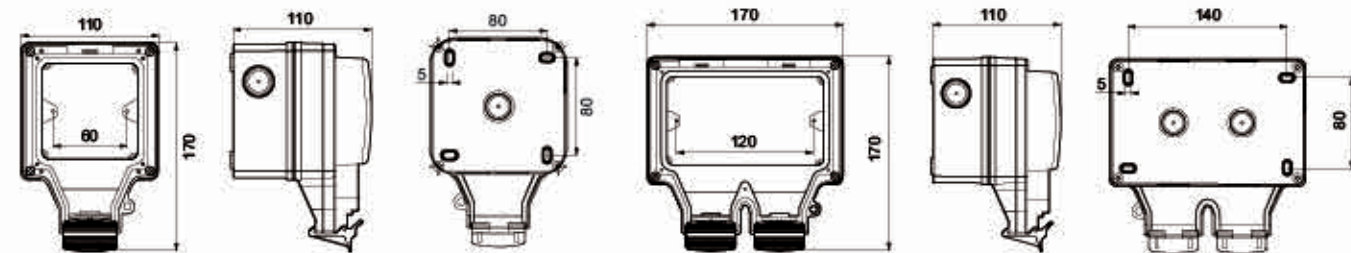

Type	A(mm)	B(mm)	C(mm)	D(mm)	E(mm)	C1 (mm)
IG5-30R-1	110	170	110	60	80	80
IG5-30R-2	170	170	100	140	80	80

**(IP66) One /Two Gang Weatherproof Socket Series**

**IG6-50R-1/2 New Energy Vehicle Charging Socket**



IG6-50R-1

**Basic Parameter:**

Rated voltage:	50A-AC250V~
Level of protection:	IP66
Dimension:	IG6-50R-1(110 × 170 × 110mm) IG6-50R-2(170 × 170 × 110mm)
Interface size:	1 Modules
Casting material:	ABS/PC

◆ For special requirements & OEM/ODM service, please consult us.



IG6-50R-2

**Available sockets:**



**Outline Drawing**

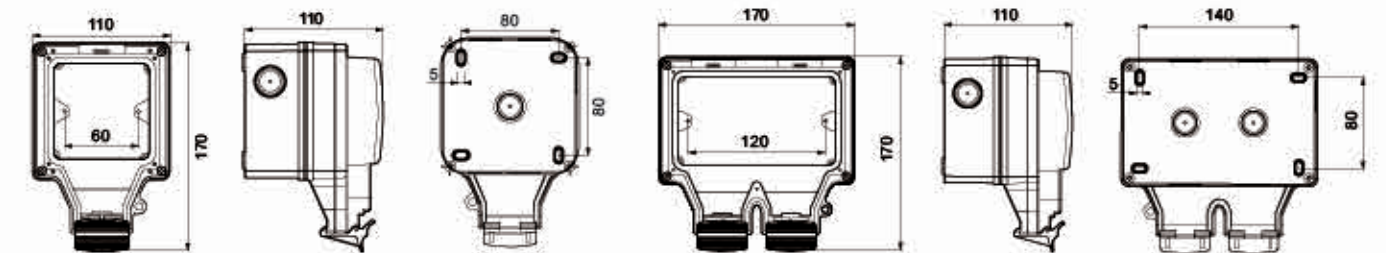

Type	A(mm)	B(mm)	C(mm)	D(mm)	E(mm)	C1 (mm)
IG6-50R-1	110	170	110	60	80	80
IG6-50R-2	170	170	100	140	80	80



**(IP66) One /Two Gang Weatherproof Socket Series**

**IG14-30R-1/2 New Energy Vehicle Charging Socket**



IG14-30R-1

**Basic Parameter:**

Rated voltage:	30A-AC125/250V~
Level of protection:	IP66
Dimension:	IG14-30R-1(110 × 170 × 110mm) IG14-30R-2(170 × 170 × 110mm)
Interface size:	1 Modules
Casting material:	ABS/PC

◆ For special requirements & OEM/ODM service, please consult us.



IG14-30R-2

**Available sockets:**



**Outline Drawing**

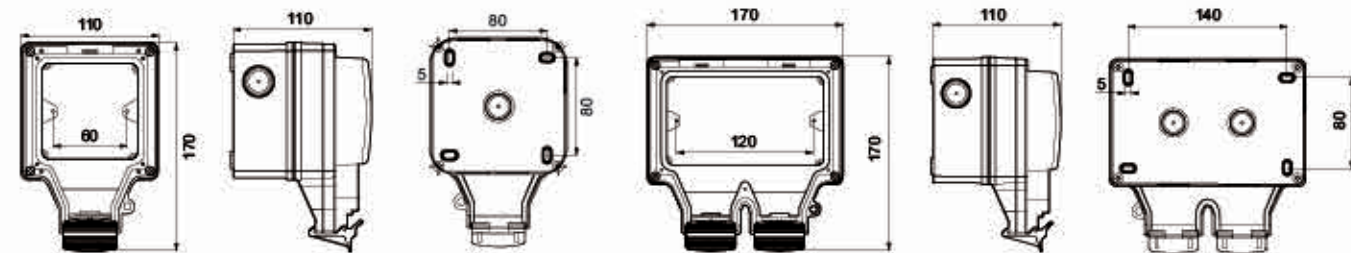

Type	A(mm)	B(mm)	C(mm)	D(mm)	E(mm)	C1 (mm)
IG14-30R-1	110	170	110	60	80	80
IG14-30R-2	170	170	100	140	80	80

**(IP66) One /Two Gang Weatherproof Socket Series**

**IG14-50R-1/2 New Energy Vehicle Charging Socket**



IG14-50R-1

**Basic Parameter:**

Rated voltage:	50A-AC125/250V~
Level of protection:	IP66
Dimension:	IG14-50R-1(110 × 170 × 110mm) IG14-50R-2(170 × 170 × 110mm)
Interface size:	1 Modules
Casting material:	ABS/PC

◆ For special requirements & OEM/ODM service, please consult us.



IG14-50R-2

**Available sockets:**



**Outline Drawing**

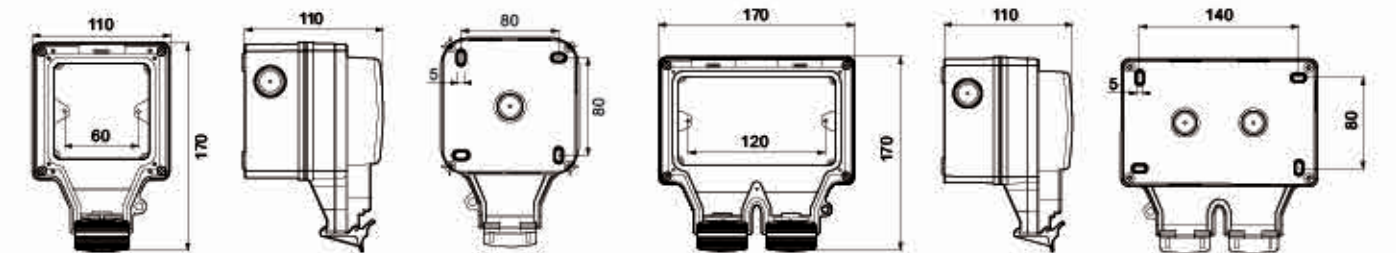

Type	A(mm)	B(mm)	C(mm)	D(mm)	E(mm)	C1 (mm)
IG14-50R-1	110	170	110	60	80	80
IG14-50R-2	170	170	100	140	80	80

(IP66) One /Two Gang Weatherproof Socket Series

IGTT-30R-1/2 New Energy Vehicle Charging Socket



IGTT-30R-1



IGTT-30R-2

Basic Parameter:

Rated voltage:	30A-AC125V~
Level of protection:	IP66
Dimension:	IGTT-30R-1(110 × 170 × 110mm) IGTT-30R-2(170 × 170 × 110mm)
Interface size:	1 Modules
Casting material:	ABS/PC

◆ For special requirements & OEM/ODM service, please consult us.

Available sockets:



Outline Drawing

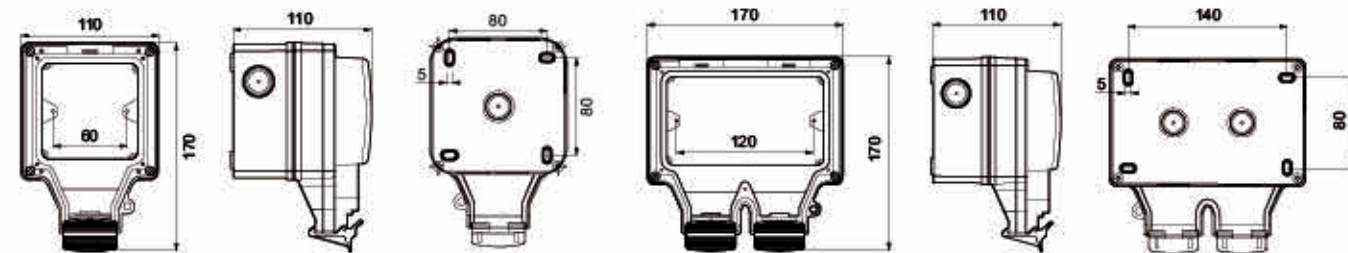

Type	A(mm)	B(mm)	C(mm)	D(mm)	E(mm)	C1 (mm)
IGTT-30R-1	110	170	110	60	80	80
IGTT-30R-2	170	170	100	140	80	80

IP66 Outdoor Weatherproof Distribution Power Box



IP66 4 Way Outdoor Weatherproof Distribution Power Box

IGCB4N-TS,IGCB4N-1G1TS, IGB4N-1G1U



IGCB4N-TS



IGCB4N-1G1TS



IGB4N-1G1U

Basic Parameter:

Rated voltage:	110-220V~
Level of protection:	IP66
Dimension:	100 × 200 × 110mm
Interface size:	4 Modules
Casting material:	ABS/PC

◆ For special requirements & OEM/ODM service,please consult us.

Available sockets:



Outline Drawing

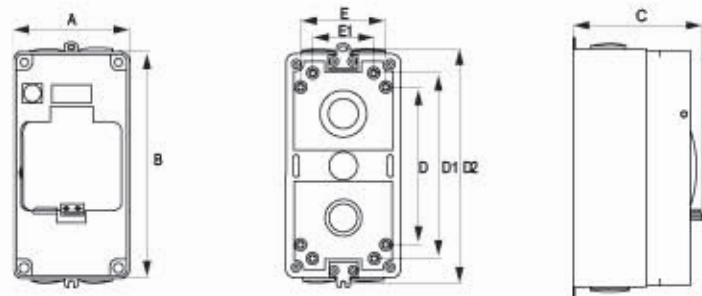

Type	A(mm)	B(mm)	C(mm)	D(mm)	E(mm)	D1 (mm)	D2(mm)	E1(mm)
IGCB4N-TS	100	200	110	140	76	165	209	55
IGCB4N-1G1TS	100	200	110	140	76	165	209	55
IGB4N-1G1U	100	200	110	140	76	165	209	55

IP66 8 Way Outdoor Weatherproof Distribution Power Box

IGCB8N-1G2S,IGCB8N-1G2SR,IGCB8N



IGCB8N-1G2S



IGCB8N-1G2SR



IGCB8N

Basic Parameter:

Rated voltage:	13A-250V~
Level of protection:	IP66
Dimension:	175 × 200 × 110mm
Interface size:	1Gang Switch 2Gang Socket
Casting material:	ABS/PC

◆ For special requirements & OEM/ODM service,please consult us.

Available sockets:



Outline Drawing

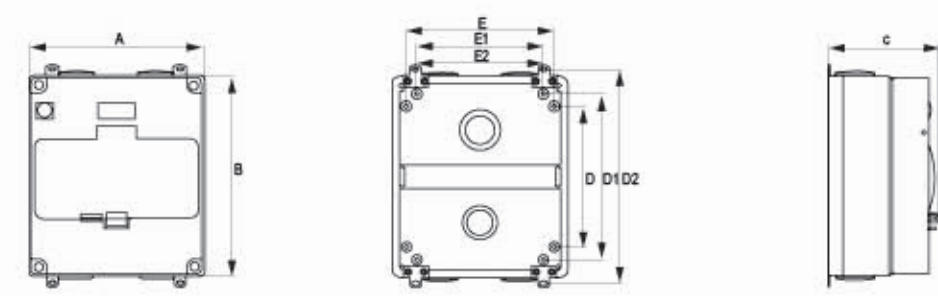

Type	A(mm)	B(mm)	C(mm)	D(mm)	E(mm)	D1 (mm)	D2(mm)	E1(mm)	E2(mm)
IGCB8N	175	200	110	140	147	165	213	126	126
IGCB8N-1G2S	175	200	110	140	147	165	213	126	126
IGCB8N-1G2SR	175	200	110	140	147	165	213	126	126

**(IP54) Swiss Open Weatherproof Socket Series**

**IG54-SW/2SW/3SW/4SW**

**IP54 WEATHER WATER  
PROOF WALL SOCKET**



◆ IG54-SW(1Gang Socket 10A-250V~)

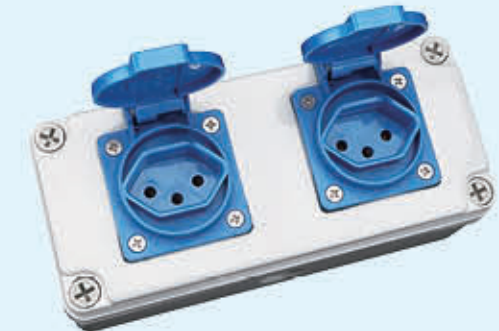

◆ IG54-2SW(2Gang Socket 10A-250V~)

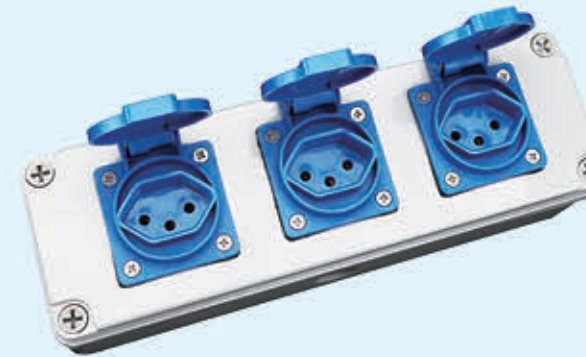

◆ IG54-3SW(3Gang Socket 10A-250V~)



◆ IG54-4SW(4Gang Socket 10A-250V~)

**Outline Drawing**

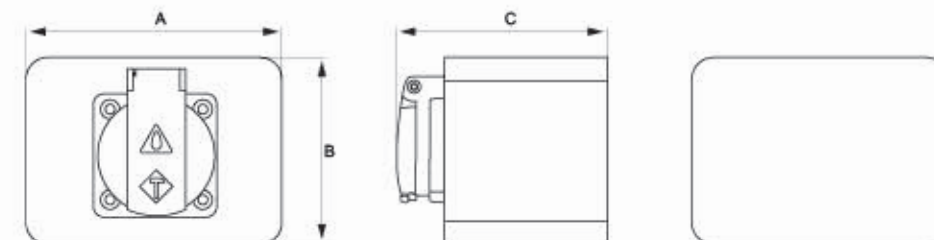

Type	A(mm)	B(mm)	C(mm)	Rated voltage	Level of protection:	Casting material
IG54-SW	110	80	90	10A/250V~	IP54	ABS/PC
IG54-2SW	180	80	90	10A/250V~	IP54	ABS/PC
IG54-3SW	250	80	90	10A/250V~	IP54	ABS/PC
IG54-4SW	250	80	90	10A/250V~	IP54	ABS/PC

(IP54) British (British Standard) Open Weatherproof Socket

IG54-S/2S/3S/4S



◆ IG54-S(1Gang Socket 13A-250V~)



◆ IG54-2S(2Gang Socket 13A-250V~)



◆ IG54-3S(3Gang Socket 13A-250V~)



◆ IG54-4S(4Gang Socket 13A-250V~)

Outline Drawing

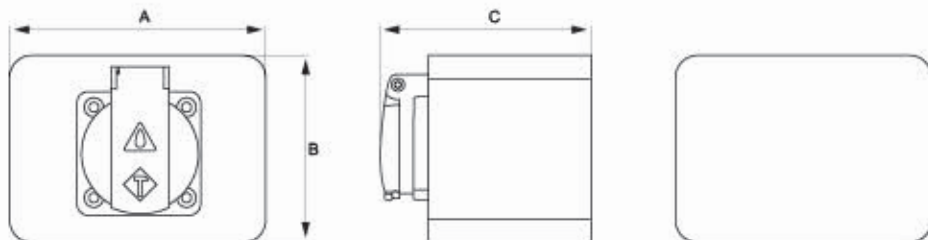

Type	A(mm)	B(mm)	C(mm)	Rated voltage	Level of protection:	Casting material
IG54-S	110	80	90	13A/250V~	IP54	ABS/PC
IG54-2S	180	80	90	13A/250V~	IP54	ABS/PC
IG54-3S	250	80	90	13A/250V~	IP54	ABS/PC
IG54-4S	250	80	90	13A/250V~	IP54	ABS/PC

DDSU/DDSY/DTSY1877  
WiFi Smart Meter



- Communication Mode: WiFi
- AMI system: remote control/recharge/reading/clear balance

**WiFi / Bluetooth Smart Single Phase Meter (Din Rail)**

**DDSU1877**



**Brief Introduction**

DDSU1877 single phase smart prepaid meter with DIN Rail installation. There are several advantages in this meter such as small dimension for easy installation, NB-IOT/GPRS/WiFi three different communication mode for more choice for different using environment, built-in relay which can trip when over load, balance run out, and so on. And there are more functions in our AMI system such as remote control, remote recharge, remote reading, remote clear balance and so on functions.

**Parameters**

Voltage	130V-265V
Current	5(60A)
Accuracy	1.0
Standard	IEC62052-11/IEC62053-21
Frequency	50Hz
Constant	1000imp/kWh
Display	LCD 5+1
Power consumption	<2W/<10VA@Un
Load control	Build-in 80A latching relay
Low balance indication	Yellow LED
Pulse	Red LED
Start current	0.4%Ib
Working temperature range	-20°C ~70°C
Humidity	< 95%
Communication	WiFi(one of three)

**Diagram**

103mm\*36mm\*70mm

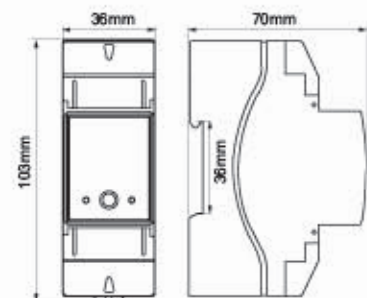

**Error limit**

Load current	Power factor	Percentage error(%)	
		Class 1	Class 2
0.05 -0.1 Ib	Cos φ =1	± 1.5	± 2.5
0.1-0.2 Ib	Cos φ =0.5L	± 1.5	± 2.0
	Cos φ =0.8C	± 1.5	
0.2 Ib-I <sub>max</sub>	Cos φ =1	± 1.0	± 2.0
	Cos φ =0.5L	± 1.0	± 2.0
	Cos φ =0.8C	± 1.5	

**Connection Diagram**



**WiFi Smart Single / Three Phase Meter (Wall Mounted)**

**DDSY1877 / DTSY1877**



**Brief Introduction**

DDSY1877 / DTSY1877 Single / three phase smart prepaid meter with WiFi communication. Built-in relay which can trip when over load, balance run out, and so on. And there are more functions in our AMI system such as remote control, remote recharge, remote reading, remote clear balance and so on functions.

For CT connection type, built-in signal relay, which is used to send signal to external switch.

**Parameters**

Model	DDSY1877	DTSY1877
Voltage	130V-265V	3*220/380V
Current	5(60)A	Direct type: 3*5(100)A; CT type: 3*1.5(6)A
Accuracy	1.0	
Standard	IEC62052-11/IEC62053-21	
Frequency	50Hz	
Constant	1000imp/kWh	Direct type:1000imp/kWh; CT type: 10000imp/kWh
Display	LCD 6+2	
Power consumption	<2W / <10VA @ Un	
Load control	Build-in 80A latching relay	Direct type: Build-in 120A latching relay CT type: Build-in 16A latching relay
Low balance indication	Yellow LED	
Pulse	Red LED	
Start current	0.4%Ib	Direct type:0.4%Ib; CT type:0.2%Ib
Working temperature range	-20°C ~ 70°C	
Humidity	< 95%	
communication	WiFi	

**Diagram**

DDSY1877

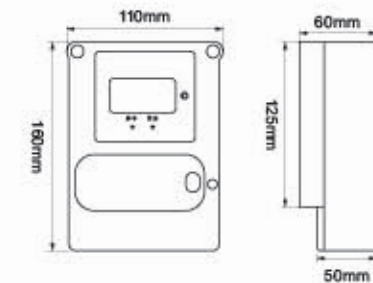

**Connection Diagram**

DIRECT TYPE

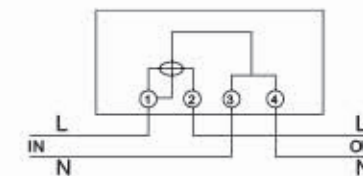

CT TYPE

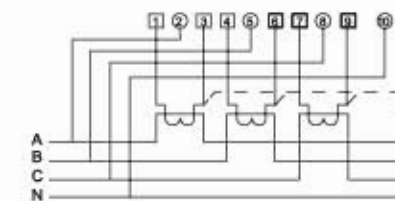

DTSY1877

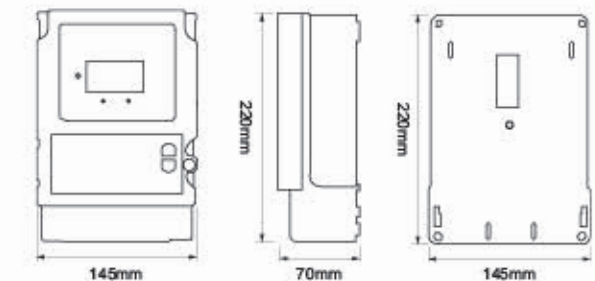

Din Rail Socket

IG-303



◆ IG-303SR



◆ IG-303FR



◆ IG-303S



◆ IG-303U



◆ IG-303SA



◆ IG-303AM



◆ IG-303TF



◆ IG-303TW

Functioning

Din Rail modular socket can be used together with our other modular products for connection of mobile devices, tools or electric and electronic non-modular equipments directly inside civil and industrial switchboards.

Technical Parameter

Model type	IG-303
Rated input voltage	250V
Rated output voltage	220V
Rated current	16A
Standard	IEC60884
Service period	Continuous operating
Installation mode	DIN Rail mounted
Connection terminals	Pillar terminal with clamp
Connection capacity	Less than 16mm <sup>2</sup>



IGER ELECTRIC

Our products are not only popular in the domestic market, but also exported to all over the world. No matter where you are, we can provide you with high quality, safe and reliable ground insertion solutions.



Pre-sale service

Provide specialized technical consulting & perfect solution to customers



In-sale service

Strictly supervise the each production link to ensure that the product is perfection



After-sales service

Reply of all technical inquiries of operate on time to ensure customer safety used